

Brushless Servomotors FastAct Series H

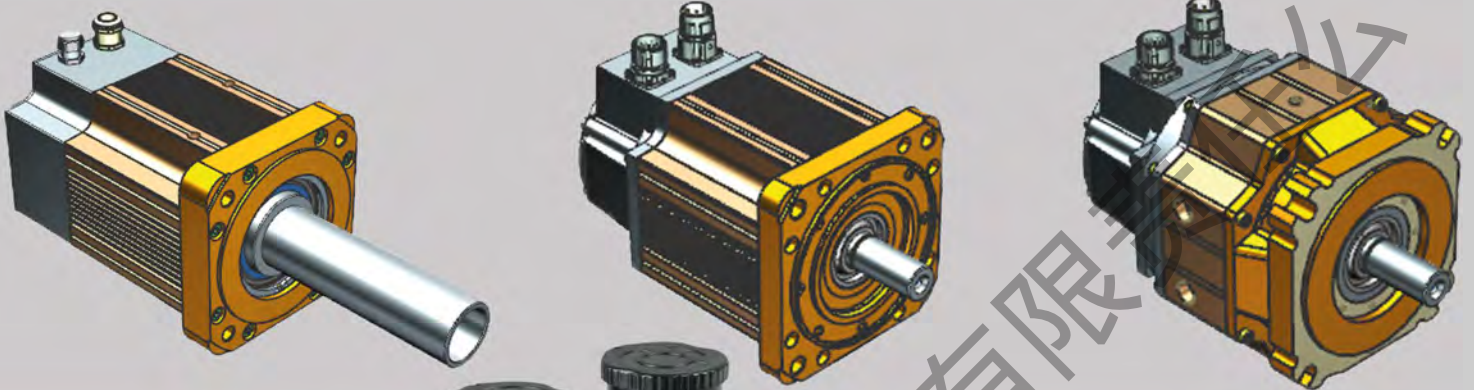

北京普天精

CONTENTS

ADVANTAGES AND TECHNICAL CHARACTERISTICS	2
OVERVIEW OF THE FASTACT H MOTORS.....	4
TECHNICAL DATA	6
Tables and curves.....	6
Drawings.....	53
Mechanical options and eccentricity data	60
Radial load diagrams	61
Signal and power connection.....	63
Cables, connectors and wiring.....	65
ORDERING	70

This catalogue is written for experts. To make sure all information necessary for operation and safety has been provided, the user must check the suitability of the products described. The products described are subject to change without notice. If you have any doubts, please contact Moog.

Moog is a registered trademark of Moog Inc. All registered trademarks mentioned herein are the property of Moog Inc.

©Moog Inc. 2016. All rights reserved. All changes are reserved.

ADVANTAGES AND TECHNICAL CHARACTERISTICS

Moog's brushless technology

- For more than 20 years, Moog has been designing and producing servomotors and drives that guarantee high dynamics, optimum power density and great reliability. Moog servomotors and drives are designed to ensure the excellent coupling needed for top machine performance levels. Thanks to a wide range of servomotors and drives, Moog can meet even the most complex application requirements. Moog servomotors and drives have been used for some time in a variety of applications, especially when compactness and reliability are amongst the fundamental requisites.

Moog's Fastact H range

- The Moog Fastact H range of servomotors are synchronous permanent magnet motors that stand out for their extremely high level of overloadability and high acceleration speeds. The Fastact H motor is available in a wide range of sizes, with nominal torques from 0.4 Nm to 831 Nm and peak torques from 1.8 Nm to 1712 Nm.

High dynamics, exceptional power density, optimum reliability

- The Fastact H motors are made with the latest materials and components to guarantee improved performance and reliability compared with the motors of previous ranges. In addition, they ensure high continuous and peak performance, and excellent dynamism.

A wide selection of personalisation options to meet most application needs

- The motors of the Fastact H range are designed to satisfy the application needs of most machine manufacturers. Moog can offer special windings to optimise the performance levels between the motor and the drive, and system costs.

Modular design

- Thanks to their modular structure, the Fastact H motors can be personalised with special shafts (various lengths and diameters, hollow shafts, etc.) or special flanges.

Extraordinary power/mass ratio with the liquid-cooled version

- Thanks to the intrinsic characteristics of the permanent magnet synchronous motors, the liquid-based cooling ensures an extraordinary power/mass ratio that enhances the efficiency of the system. The Fastact WH version with liquid cooling guarantees an additional performance increase in continuous service. The liquid-cooled motors offer greater productivity thanks to the increase in the number of cycles and the high speed.

Feedback systems

- Apart from the standard resolver and encoder systems, the Fastact H motors can also be equipped with special feedback systems.

Technical characteristics

- rare earth magnets
- three-phase star winding
- IP65 protection, in compliance with IEC 60034-5 (2000)
- Class F insulation
- ambient temperature: -25°C - +40°C (reduced performance with higher ambient temperatures)
- altitude no greater than 1000m a.s.l (reduced performance with higher altitudes)
- storage temperature: -25°C - +70°C
- cooling IC 00 41 (closed, non-ventilated machine), in compliance with CEI EN60034-6 (1995)
- standard feedback: 2-pole resolver, absolute single turn, absolute multi-turn encoder
- emergency brake
- B5 flange
- shielded bearings with lifelong lubrication
- construction form and assembly configuration IM B5, IM V1 and IM V3, in compliance with EN60034-7 (1993)
- impact: 30g for 11ms on the two axes, in compliance with IEC 68-2-27 (1987)
- vibrations: 0.3mm peak-peak up to 57 Hz, 2g from 57 Hz to 150 Hz, on the two axes, in compliance with IEC 68-2-6 (1995)
- smooth shaft with threaded hole for keying, in compliance with DIN 332 (1983)
- balancing degree Q = 2.5, in compliance with ISO 1940-1 (NB: balancing with key for key option)
- colour: black
- thermal protection via PTC, with threshold of 130°C
- straight or rotating connectors
- MTBF at 20°C, $\Delta\theta$ winding = 105°C, motor fixed to the ground: 100,000 hours

For liquid-cooled motors:

- ambient temperature: 0°C - 40°C
- forced liquid cooling: liquid inlet temperature: 25°C - 40°C; in any case, this temperature must be higher than the motor ambient temperature. If the inlet liquid temperature is higher than 40°C, performance levels will fall
- straight or rotating connectors (connector box for some versions of FAWH200 and FAWH275)

Notes:

the cooling liquid must not contain substances that could deposit and thereby obstruct the cooling circuit. If you have any doubts, you are advised to occasionally check the flow of the liquid. In any case, refer to the installation instructions.

OVERVIEW OF THE FASTACT H MOTORS

Model/Code	Cooling	Nominal torque (Nm)	Maximum torque (Nm)	Rotor inertia (kgcm ²)	Nominal speed (rpm)	Square Flange (mm)
H100V2	Natural	2.9	12.5	1.77	3000, 4500, 6000	100
H100V4	Natural	5.3	24.5	3.4	3000, 4500, 6000	100
H100V6	Natural	7.7	36.5	5.05	2000, 3000, 4500	100
H100V8	Natural	10.2	49	6.8	2000, 3000, 4500	100
H115V2	Natural	4.1	15.9	3.92	3000, 4500, 6000	115
H115V4	Natural	8	32.1	7.52	2000, 3000, 4500	115
H115V6	Natural	11.4	48.3	11.12	2000, 3000, 4500	115
H145V2	Natural	10.7	36.7	11.2	2000, 3000, 4500	145
H145V4	Natural	19.1	73.4	21.7	2000, 3000, 4000	145
H145V6	Natural	26.9	110.1	32.2	2000, 3000, 4000	145
H145V8	Natural	33.5	146.8	42.7	2000, 3000, 4000	145
H200V2	Natural	34	95	93	2000, 3000, 4500	200
H200P2	Natural	45.5	174	93	1400, 2200, 3000	200
H200V3	Natural	49	146	135	2000, 3000, 3900	200
H200P3	Natural	65	267	135	1400, 1800, 2200	200
H200V4	Natural	63.4	196	177	1400, 2000, 3000	200
H200P4	Natural	82.5	360	177	1400, 1800, 2000	200
H200V6	Natural	89.7	297	261	1200, 2000, 2500	200
H200P6	Natural	117.8	545	261	1100, 1500, 1800	200
H200V8	Natural	115.2	398	344	1200, 1600, 2000	200
H200P8	Natural	148.2	725	344	800, 1000, 1400	200
H275V3	Natural	192	455	687	1200	275
H275V4	Natural	260	617	919	1000, 1500	275
H275V5	Natural	328	781	1156	1000	275

Model/Code	Cooling	Nominal torque (Nm)	Maximum torque (Nm)	Rotor inertia (kgcm ²)	Nominal speed (rpm)	Square Flange (mm)
WH100V2	Liquid	5.5	12.5	1.77	3000, 4500, 6000	100
WH100V4	Liquid	11	24.5	3.4	3000, 4500, 6000	100
WH100V6	Liquid	16.6	36.5	5.05	2000, 3000, 4500	100
WH100V8	Liquid	22.6	49	6.8	2000, 3000, 4500	100
WH145V2	Liquid	18.5	36.7	11.2	2000, 3000, 4500	145
WH145V4	Liquid	37.9	73.4	21.7	2000, 3000, 4000	145
WH145V6	Liquid	58.3	110.1	32.2	2000, 3000, 4000	145
WH145V8	Liquid	77.5	146.8	42.7	2000, 3000, 4000	145
WH200V2	Liquid	48.2	95	93	2000, 3000, 4500	200
WH200P2	Liquid	69.5	174	93	1400, 2200, 3500	200
WH200V3	Liquid	75.5	146	135	2000, 3000, 3900	200
WH200P3	Liquid	107.4	267	135	1800, 2200, 3500	200
WH200V4	Liquid	103.4	196	177	1400, 2000, 3000	200
WH200P4	Liquid	146	360	177	1400, 1800, 2700	200
WH200V5	Liquid	131.5	248	220	2000, 2500, 3300	200
WH200P5	Liquid	189	456	220	1400, 1800, 2600	200
WH200V6	Liquid	156.3	297	261	1200, 2000, 2500	200
WH200P6	Liquid	227.3	545	261	1100, 1600, 2200	200
WH200V8	Liquid	213.6	398	344	1200, 1600, 2000	200
WH200P8	Liquid	305.8	725	344	1000, 1400, 1800	200
WH275V3	Liquid	340	457	687	1200, 2000	275
WH275P3	Liquid	367	721	687	800, 1100	275
WH275V4	Liquid	461	617	919	1000, 1500	275
WH275P4	Liquid	490	974	919	1100	275
WH275V5	Liquid	583	781	1156	1000, 1500	275
WH275P5	Liquid	602	1232	1156	800	275
WH275P7	Liquid	831	1712	1600	800	275

TECHNICAL DATA

Tables and curves

Size H100 - Natural cooling					
Characteristics and nominal values with sinusoidal drives					
Size		H100-V2-030	H100-V2-045	H100-V2-060	Units
Nominal torque, continuous duty, locked rotor	M_0	2.84 [25.1]	2.90 [25.7]	2.88 [25.5]	Nm [lb.in]
Nominal torque, continuous duty, nominal speed	M_N	2.60 [23.0]	2.50 [22.1]	2.23 [19.7]	Nm [lb.in]
Maximum torque	M_{max}	12.5 [110.6]	12.5 [110.6]	12.5 [110.6]	Nm [lb.in]
Nominal speed	n_N	3000	4500	6000	rpm
Maximum speed	n_{max}	4483	7419	8720	rpm
Rated current, locked rotor	I_0	1.77	3.0	3.5	Arms
Peak current	I_p	10	16	19	Arms
Output power in continuous service at nominal speed	P_N	0.82 [1.10]	1.18 [1.58]	1.40 [1.88]	kW [hp]
Torque constant	k_T	1.60 [14.2]	0.97 [8.6]	0.82 [7.3]	Nm/Arms [lb.in/Arms]
Voltage constant	k_e	102.6	62.0	52.8	Vrms/krpm
Thermal time constant	τ_{Th}	1290	1290	1290	sec
Winding resistance between phases at 25°C	R_{tt}	16.20	5.64	4.15	Ohm
Inductance between phases	L_{tt}	74.0	27.2	19.8	mH
Moment of rotor inertia	J	1.77 [15.7]	1.77 [15.7]	1.77 [15.7]	kgcm ² [lb-in.sec ² x 10 ⁻⁴]
Weight (without brake)	m	3.7 [8.1]	3.7 [8.1]	3.7 [8.1]	kg [lb]
Recommended cable section (4x)	S	1.5	1.5	1.5	mm ²
Recommended terminal type	-	Connector Size 1	Connector Size 1	Connector Size 1	-

Optional Holding Brake		Unit
Static braking torque (at 120°C)	9 [79.7]	Nm [lb.in]
Additional weight	0.52 [1.1]	kg [lb]
Additional inertia	0.55 [4.9]	kgcm ² [lb-in.sec ² x 10 ⁻⁴]
Power	15	Watt
Power supply voltage (+6 - 10%)	24	VDC

Notes:

- motor performance levels measured with Moog drives of the appropriate size
- performance in continuous service with $\Delta\theta$ winding = 105°C
- number of motor poles: 6
- DC Link voltage 565V

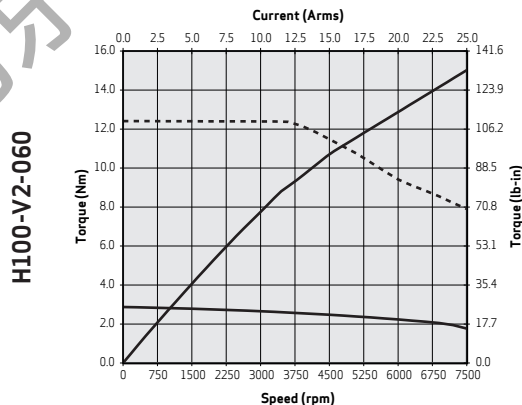
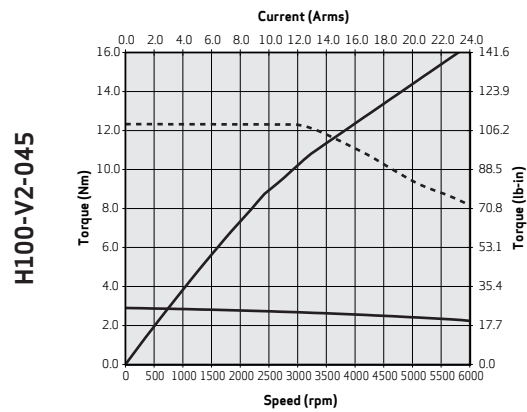
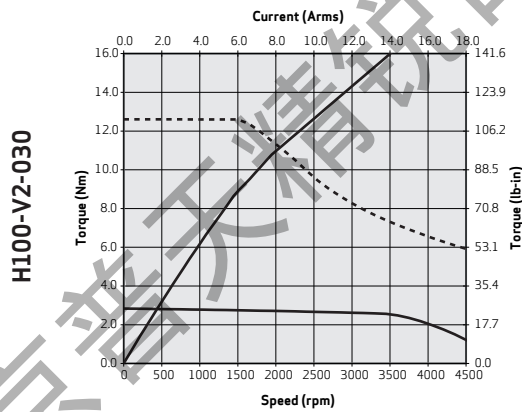

Size H100 - Natural cooling					
Characteristics and nominal values with sinusoidal drives					
Size		H100-V4-030	H100-V4-045	H100-V4-060	Units
Nominal torque, continuous service, locked rotor	M_0	5.34 [47.3]	5.26 [46.6]	5.33 [47.2]	Nm [lb.in]
Nominal torque, continuous service, nominal speed	M_N	4.67 [41.3]	4.00 [35.4]	3.19 [28.2]	Nm [lb.in]
Maximum torque	M_{max}	24.5 [216.8]	24.5 [216.8]	24.4 [216.0]	Nm [lb.in]
Nominal speed	n_N	3000	4500	6000	rpm
Maximum speed	n_{max}	4882	6174	8185	rpm
Rated current, locked rotor	I_0	3.62	4.5	6.1	Arms
Peak current	I_p	21	26	35	Arms
Power yield in continuous service at nominal speed	P_N	1.47 [1.97]	1.90 [2.55]	2.00 [2.68]	kW [hp]
Torque constant	k_T	1.48 [13.1]	1.17 [10.3]	0.88 [7.8]	Nm/Arms [lb.in./Arms]
Voltage constant	k_e	94.2	74.5	56.2	Vrms/krpm
Thermal time constant	τ_{Th}	1380	1380	1380	sec
Resistance between the phases at 25°C	R_{tt}	4.70	3.02	1.68	Ohm
Inductance between the phases	L_{tt}	26.2	16.4	9.4	mH
Moment of rotor inertia	J	3.4 [30.1]	3.4 [30.1]	3.4 [30.1]	kgcm ² [lb-in.sec ² x 10 ⁻⁴]
Weight (without brake)	m	5.6 [12.4]	5.6 [12.4]	5.6 [12.4]	kg [lb]
Recommended cable section (4x)	S	1.5	1.5	1.5	mm ²
Recommended terminal type	-	Connector Size 1	Connector Size 1	Connector Size 1	-

Optional Holding Brake		Unit
Static braking torque (at 120°C)	9 [79.7]	Nm [lb.in]
Additional weight	0.52 [1.1]	kg [lb]
Additional inertia	0.55 [4.9]	kgcm ² [lb-in.sec ² x 10 ⁻⁴]
Power	15	Watt
Power supply voltage (+6 - 10%)	24	VDC

Notes:

- motor performance levels measured with Moog drives of the appropriate size
- performance in continuous service with $\Delta\theta$ winding = 105°C
- number of motor poles: 6
- DC Link voltage 565V

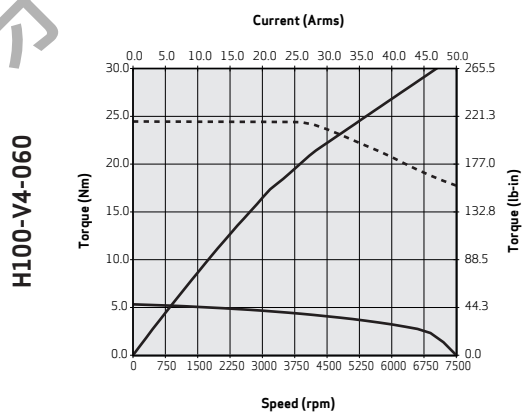
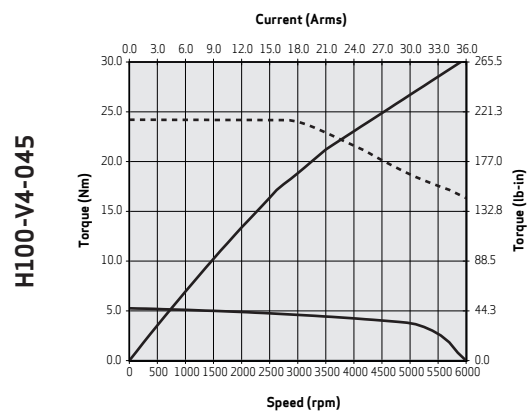
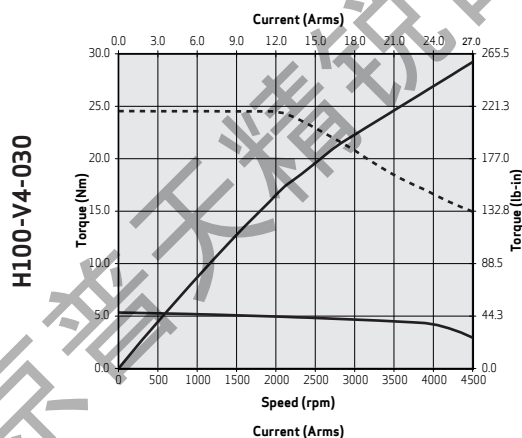

Size H100 - Natural cooling					
Characteristics and nominal values with sinusoidal drives					
Size		H100-V6-020	H100-V6-030	H100-V6-045	Units
Nominal torque, continuous service, locked rotor	M_0	7.60 [67.3]	7.56 [66.9]	7.73 [68.4]	Nm [lb.in]
Nominal torque, continuous service, nominal speed	M_N	6.90 [61.0]	6.32 [55.9]	5.28 [46.8]	Nm [lb.in]
Maximum torque	M_{max}	36.5 [323.1]	36.5 [323.1]	36.5 [323.1]	Nm [lb.in]
Nominal speed	n_N	2000	3000	4500	rpm
Maximum speed	n_{max}	2930	4097	6032	rpm
Rated current, locked rotor	I_0	3.10	4.30	6.46	Arms
Peak current	I_p	19	26	39	Arms
Power yield in continuous service at nominal speed	P_N	1.44 [1.94]	1.99 [2.66]	2.49 [3.34]	kW [hp]
Torque constant	k_T	2.46 [21.8]	1.76 [15.6]	1.20 [10.6]	Nm/Arms [lb-in/Arms]
Voltage constant	k_e	157.0	112.3	76.3	Vrms/krpm
Thermal time constant	τ_{Th}	1500	1500	1500	sec
Resistance between the phases at 25°C	R_{tt}	7.56	3.92	1.73	Ohm
Inductance between the phases	L_{tt}	44.8	23.0	10.6	mH
Moment of rotor inertia	J	5.05 [44.7]	5.05 [44.7]	5.05 [44.7]	kgcm ² [lb-in.sec ² x 10 ⁻⁴]
Weight (without brake)	m	7.6 [16.7]	7.6 [16.7]	7.6 [16.7]	kg [lb]
Recommended cable section (4x)	S	1.5	1.5	1.5	mm ²
Recommended terminal type	-	Connector Size 1	Connector Size 1	Connector Size 1	-

Optional Holding Brake		Unit
Static braking torque (at 120°C)	9 [79.7]	Nm [lb.in]
Additional weight	0.52 [1.1]	kg [lb]
Additional inertia	0.55 [4.9]	kgcm ² [lb-in.sec ² x 10 ⁻⁴]
Power	15	Watt
Power supply voltage (+6 - 10%)	24	VDC

Notes:

- motor performance levels measured with Moog drives of the appropriate size
- performance in continuous service with $\Delta\theta$ winding = 105°C
- number of motor poles: 6
- DC Link voltage 565V

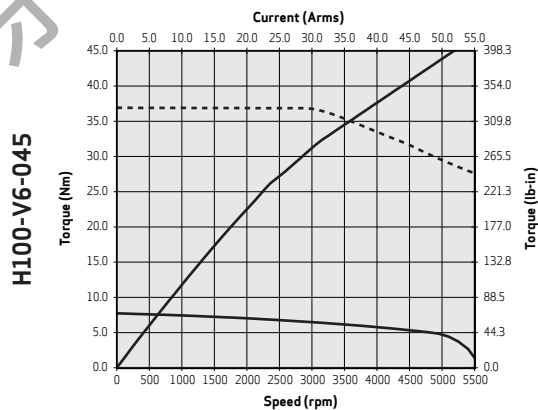
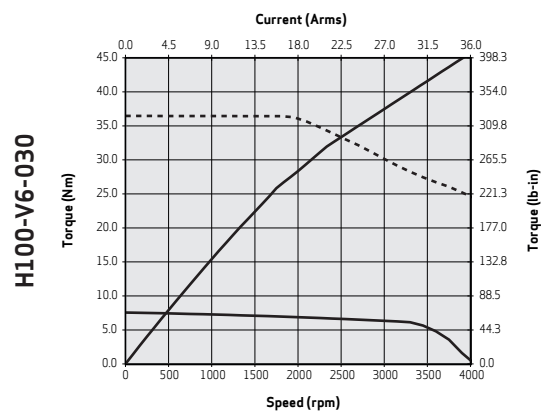
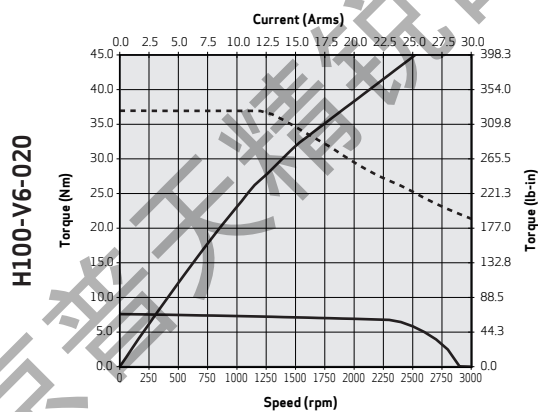

Size H100 - Natural cooling					
Characteristics and nominal values with sinusoidal drives					
Size		H100-V8-020	H100-V8-030	H100-V8-045	Units
Nominal torque, continuous service, locked rotor	M_O	9.70 [85.9]	10.20 [90.3]	9.98 [88.3]	Nm [lb.in]
Nominal torque, continuous service, nominal speed	M_N	8.66 [76.6]	8.26 [73.1]	6.21 [55.0]	Nm [lb.in]
Maximum torque	M_{max}	49 [433.7]	49 [433.7]	49 [433.7]	Nm [lb.in]
Nominal speed	n_N	2000	3000	4500	rpm
Maximum speed	n_{max}	2725	3796	5838	rpm
Rated current, locked rotor	I_O	3.66	5.39	8.10	Arms
Peak current	I_P	23	32	49	Arms
Power yield in continuous service at nominal speed	P_N	1.81 [2.43]	2.60 [3.48]	2.93 [3.92]	kW [hp]
Torque constant	k_T	2.65 [23.5]	1.90 [16.8]	1.24 [10.9]	Nm/Arms [lb-in./Arms]
Voltage constant	k_e	168.8	121.2	78.8	Vrms/krpm
Thermal time constant	τ_{Th}	1560	1560	1560	sec
Resistance between the phases at 25°C	R_{tt}	6.17	2.85	1.27	Ohm
Inductance between the phases	L_{tt}	37.0	19.2	8.0	mH
Moment of rotor inertia	J	6.8 [60.2]	6.8 [60.2]	6.8 [60.2]	kgcm ² [lb-in.sec ² x 10 ⁻⁴]
Weight (without brake)	m	9.6 [21.1]	9.6 [21.1]	9.6 [21.1]	kg [lb]
Recommended cable section (4x)	S	1.5	1.5	1.5	mm ²
Recommended terminal type	-	Connector Size 1	Connector Size 1	Connector Size 1	-

Optional Holding Brake		Unit
Static braking torque (at 120°C)	9 [79.7]	Nm [lb.in]
Additional weight	0.52 [1.1]	kg [lb]
Additional inertia	0.55 [4.9]	kgcm ² [lb-in.sec ² x 10 ⁻⁴]
Power	15	Watt
Power supply voltage (+6 - 10%)	24	V DC

Notes:

- motor performance levels measured with Moog drives of the appropriate size
- performance in continuous service with $\Delta\theta$ winding = 105°C
- number of motor poles: 6
- DC Link voltage 565V
- handbrake available upon request

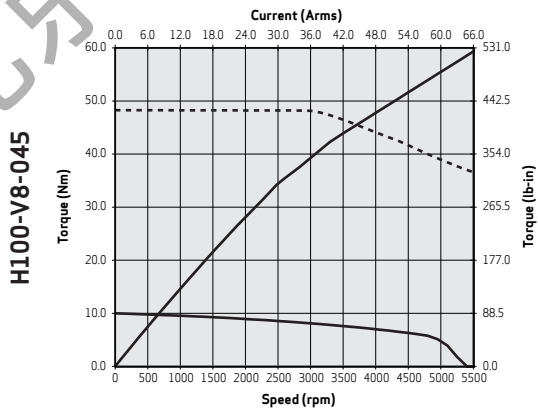
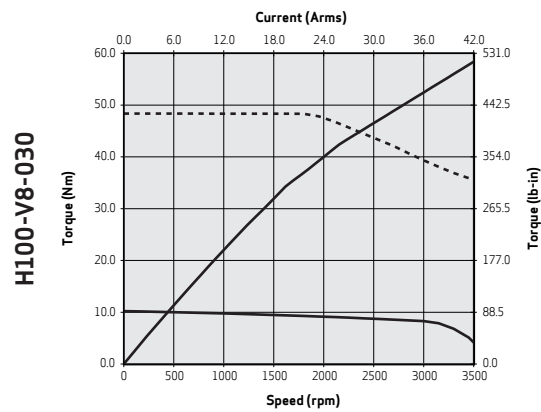
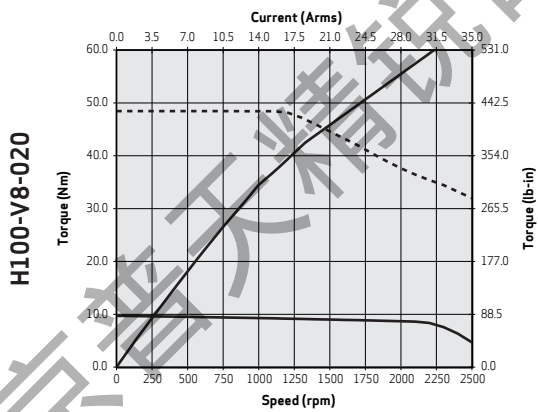

Size H115 - Natural cooling

Characteristics and nominal values with sinusoidal drives

Size		H115-V2-030	H115-V2-045	H115-V2-060	Units
Nominal torque, continuous service, locked rotor	M_O	4.13 [36.6]	4.23 [37.4]	4.17 [36.9]	Nm [lb.in]
Nominal torque, continuous service, nominal speed	M_N	3.49 [30.9]	3.28 [29.0]	2.53 [22.4]	Nm [lb.in]
Maximum torque	M_{max}	15.9 [140.4]	15.9 [140.4]	15.9 [140.4]	Nm [lb.in]
Nominal speed	n_N	3000	4500	6000	rpm
Maximum speed	n_{max}	3669	5556	7203	rpm
Rated current, locked rotor	I_O	2.02	3.1	4.0	Arms
Peak current	I_p	8.5	12.9	16.7	Arms
Power yield in continuous service at nominal speed	P_N	1.1 [1.47]	1.55 [2.07]	1.59 [2.13]	kW [hp]
Torque constant	k_T	2.04 [18.1]	1.35 [11.9]	1.04 [9.2]	Nm/Arms [lb-in/Arms]
Voltage constant	k_e	125.4	82.8	63.9	Vrms/krpm
Thermal time constant	τ_{Th}	1150	1150	1150	sec
Resistance between the phases at 25°C	R_{tt}	14.76	6.11	3.80	Ohm
Inductance between the phases	L_{tt}	62.9	27.4	16.3	mH
Moment of rotor inertia	J	3.92 [34.7]	3.92 [34.7]	3.92 [34.7]	kgcm ² [lb-in.sec ² x 10 ⁻⁴]
Weight (without brake)	m	5.6 [12.4]	5.6 [12.4]	5.6 [12.4]	kg [lb]
Recommended cable section (4x)	S	1.5	1.5	1.5	mm ²
Recommended terminal type	-	Connector Size 1	Connector Size 1	Connector Size 1	-

Optional Holding Brake		Unit
Static braking torque (at 120°C)	9 [79.7]	Nm [lb.in]
Additional weight	0.52 [1.1]	kg [lb]
Additional inertia	0.55 [4.9]	kgcm ² [lb-in.sec ² x 10 ⁻⁴]
Power	15	Watt
Power supply voltage (+6 - 10%)	24	VDC

Notes:

- motor performance levels measured with Moog drives of the appropriate size
- performance in continuous service with $\Delta\theta$ winding = 105°C
- number of motor poles: 6
- DC Link voltage 565V

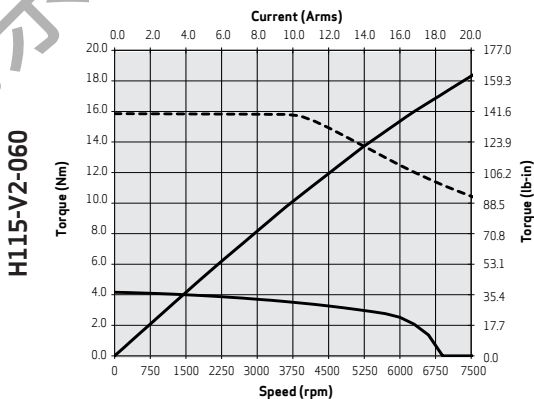
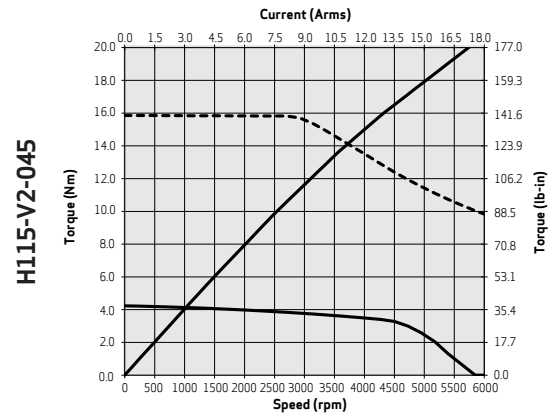
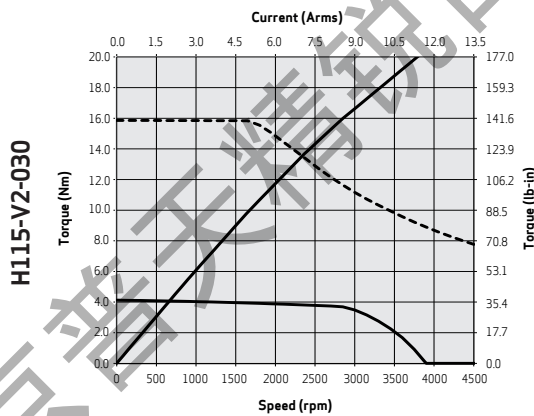

Size H115 - Natural cooling

Characteristics and nominal values with sinusoidal drives

Size		H115-V4-020	H115-V4-030	H115-V4-045	Units
Nominal torque, continuous service, locked rotor	M_O	8.00 [70.8]	7.95 [70.4]	7.89 [69.8]	Nm [lb.in]
Nominal torque, continuous service, nominal speed	M_N	7.23 [64.0]	6.49 [57.5]	4.87 [43.1]	Nm [lb.in]
Maximum torque	M_{max}	32.1 [284.1]	32.1 [284.1]	32.1 [284.1]	Nm [lb.in]
Nominal speed	n_N	2000	3000	4500	rpm
Maximum speed	n_{max}	2745	4178	5652	rpm
Rated current, locked rotor	I_O	2.93	4.4	6.0	Arms
Peak current	I_P	13	19.6	26.5	Arms
Power yield in continuous service at nominal speed	P_N	1.51 [2.03]	2.04 [2.74]	2.3 [3.08]	kW [hp]
Torque constant	k_T	2.73 [24.2]	1.79 [15.9]	1.33 [11.7]	Nm/Arms [lb-in/Arms]
Voltage constant	k_e	167.6	110.1	81.4	Vrms/krpm
Thermal time constant	τ_{Th}	1250	1250	1250	sec
Resistance between the phases at 25°C	R_{tt}	8.59	3.76	2.09	Ohm
Inductance between the phases	L_{tt}	52.7	22.8	12.4	mH
Moment of rotor inertia	J	7.52 [66.6]	7.52 [66.6]	7.52 [66.6]	kgcm ² [lb-in.sec ² x 10 ⁻⁴]
Weight (without brake)	m	7.9 [17.4]	7.9 [17.4]	7.9 [17.4]	kg [lb]
Recommended cable section (4x)	S	1.5	1.5	1.5	mm ²
Recommended terminal type	-	Connector Size 1	Connector Size 1	Connector Size 1	-

Optional Holding Brake		Unit
Static braking torque (at 120°C)	9 [79.7]	Nm [lb.in]
Additional weight	0.52 [1.1]	kg [lb]
Additional inertia	0.55 [4.9]	kgcm ² [lb-in.sec ² x 10 ⁻⁴]
Power	15	Watt
Power supply voltage (+6 - 10%)	24	V DC

Notes:

- motor performance levels measured with Moog drives of the appropriate size
- performance in continuous service with $\Delta\theta$ winding = 105°C
- number of motor poles: 6
- DC Link voltage 565V

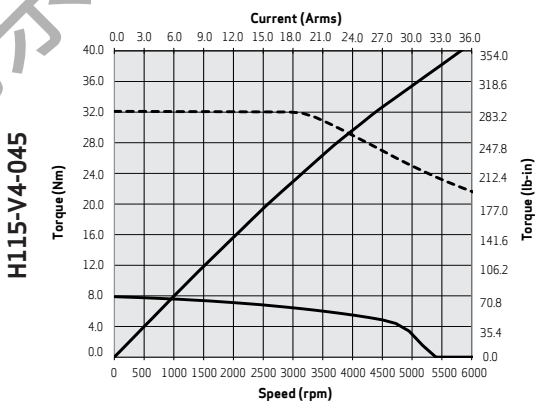
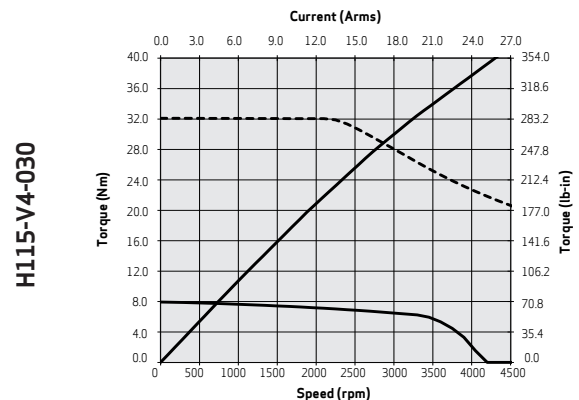
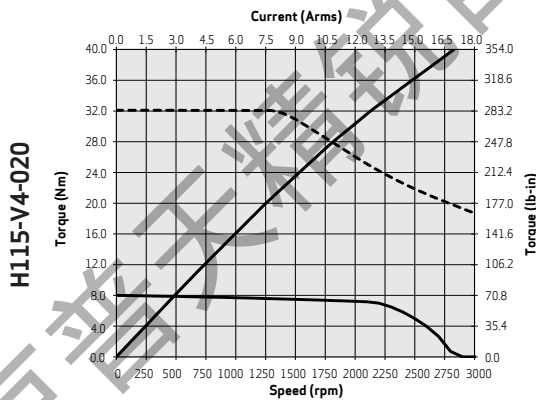

Size H115 - Natural cooling					
Characteristics and nominal values with sinusoidal drives					
Size		H115-V6-020	H115-V6-030	H115-V6-045	Units
Nominal torque, continuous service, locked rotor	M_D	11.47 [36.6]	11.38 [100.7]	11.21 [99.2]	Nm [lb.in]
Nominal torque, continuous service, nominal speed	M_N	10.05 [88.9]	8.69 [76.9]	5.28 [46.7]	Nm [lb.in]
Maximum torque	M_{max}	48.3 [427.8]	48.3 [427.8]	48.3 [427.8]	Nm [lb.in]
Nominal speed	n_N	2000	3000	4500	rpm
Maximum speed	n_{max}	2774	3754	5801	rpm
Rated current, locked rotor	I_D	4.24	5.70	8.68	Arms
Peak current	I_p	20	26.5	40.9	Arms
Power yield in continuous service at nominal speed	P_N	2.1 [2.82]	2.73 [3.66]	2.49 [3.33]	kW [hp]
Torque constant	k_T	2.7 [23.9]	2 [17.7]	1.29 [11.4]	Nm/Arms [lb-in/Arms]
Voltage constant	k_e	165.4	122.6	79.3	Vrms/krpm
Thermal time constant	τ_{th}	1350	1350	1350	sec
Resistance between the phases at 25°C	R_{tt}	4.84	2.70	1.16	Ohm
Inductance between the phases	L_{tt}	33.7	18.4	7.7	mH
Moment of rotor inertia	J	11.12 [98.4]	11.12 [98.4]	11.12 [98.4]	kgcm ² [lb-in.sec ² x 10 ⁻⁴]
Weight (without brake)	m	10.2 [22.5]	10.2 [22.5]	10.2 [22.5]	kg [lb]
Recommended cable section (4x)	S	1.5	1.5	1.5	mm ²
Recommended terminal type	-	Connector Size 1	Connector Size 1	Connector Size 1	-

Optional Holding Brake		Unit
Static braking torque (at 120°C)	9 [79.7]	Nm [lb.in]
Additional weight	0.52 [1.1]	kg [lb]
Additional inertia	0.55 [4.9]	kgcm ² [lb-in.sec ² x 10 ⁻⁴]
Power	15	Watt
Power supply voltage (+6 - 10%)	24	V DC

Notes:

- motor performance levels measured with Moog drives of the appropriate size
- performance in continuous service with $\Delta\theta$ winding = 105°C
- number of motor poles: 6
- DC Link voltage 565V

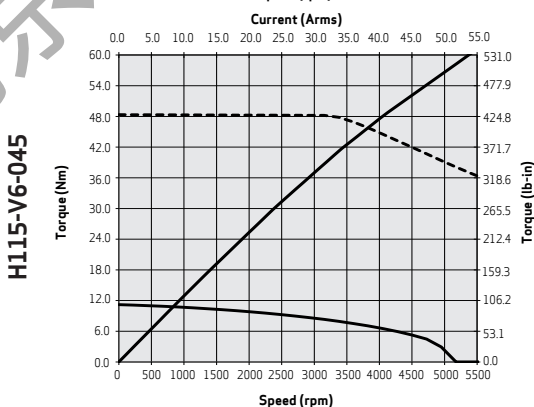
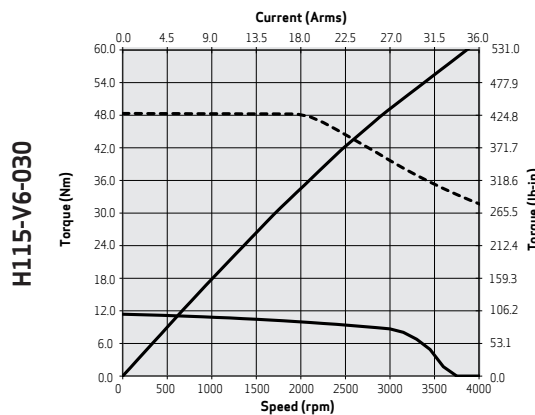
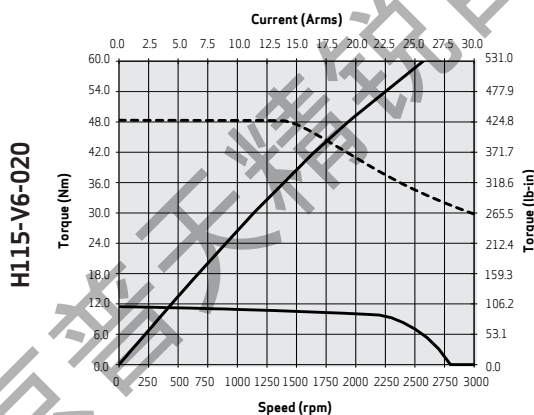

Size H145 - Natural cooling					
Characteristics and nominal values with sinusoidal drives					
Size		H145-V2-020	H145-V2-030	H145-V2-045	Units
Nominal torque, continuous duty, locked rotor	M_0	0.7 [94.6]	10.7 [94.6]	10.7 [94.6]	Nm [lb.in]
Nominal torque, continuous service, nominal speed	M_N	10.1 [89.4]	9.5 [84.3]	8.2 [72.8]	Nm [lb.in]
Maximum torque	M_{max}	36.7 [324.8]	36.7 [324.8]	36.7 [324.8]	Nm [lb.in]
Nominal speed	n_N	2000	3000	4500	rpm
Maximum speed	n_{max}	2773	4159	6932	rpm
Rated current, locked rotor	I_0	4.01	6.0	10.0	Arms
Peak current	I_p	16	24	40	Arms
Power yield in continuous service at nominal speed	P_N	2.1 [2.84]	3.0 [4.01]	3.9 [5.20]	kW [hp]
Torque constant	k_T	2.66 [23.5]	1.78 [15.7]	1.07 [9.4]	Nm/Arms [lb-in/Arms]
Voltage constant	k_e	165.9	110.6	66.4	Vrms/krpm
Thermal time constant	τ_{Th}	1180	1180	1180	sec
Resistance between the phases at 25°C	R_{tt}	7.03	3.12	1.13	Ohm
Inductance between the phases	L_{tt}	55.6	24.7	8.9	mH
Moment of rotor inertia	J	11.2 [99.1]	11.2 [99.1]	11.2 [99.1]	kgcm ² [lb-in.sec ² x 10 ⁻⁴]
Weight (without brake)	m	11.0 [24.3]	11.0 [24.3]	11.0 [24.3]	kg [lb]
Recommended cable section (4x)	S	1.5	1.5	1.5	mm ²
Recommended terminal type	-	Connector Size 1	Connector Size 1	Connector Size 1	-

Optional Holding Brake		Unit
Static braking torque (at 120°C)	22 [194.7]	Nm [lb.in]
Additional weight	1.5 [3.3]	kg [lb]
Additional inertia	3 [26.6]	kgcm ² [lb-in.sec ² x 10 ⁻⁴]
Power	19	Watt
Power supply voltage (+6 - 10%)	24	VDC

Notes:

- motor performance levels measured with Moog drives of the appropriate size
- performance in continuous service with $\Delta\theta$ winding = 105°C
- number of motor poles: 6
- DC Link voltage 565V

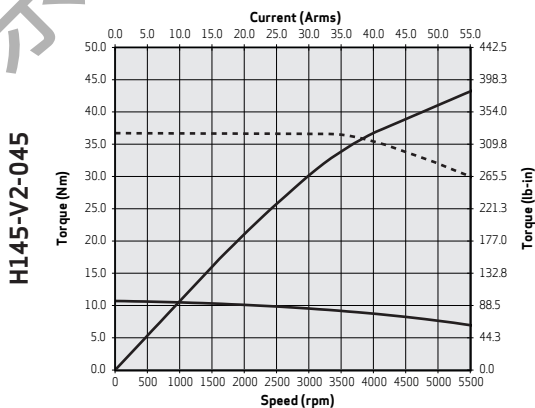
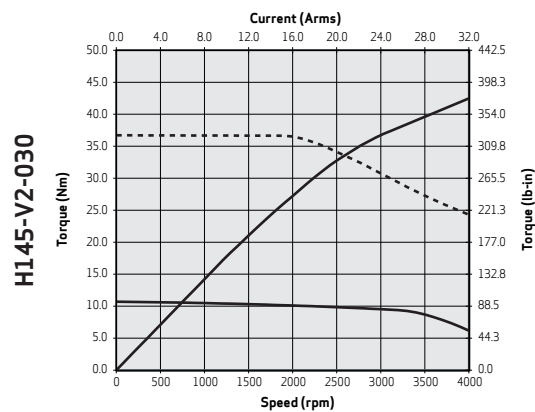
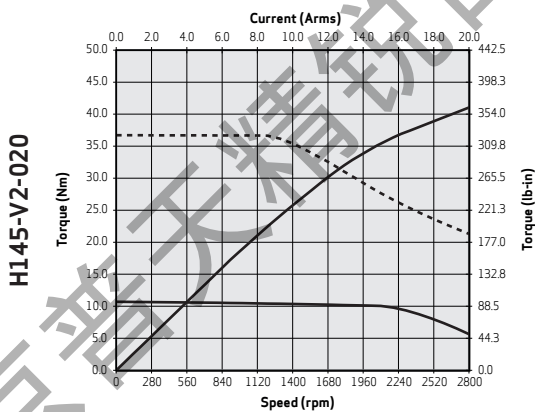

Size H145 - Natural cooling					
Characteristics and nominal values with sinusoidal drives					
Size		H145-V4-020	H145-V4-030	H145-V4-040	Units
Nominal torque, continuous service, locked rotor	M_0	19.1 [169.2]	19.1 [169.2]	18.7 [165.5]	Nm [lb.in]
Nominal torque, continuous service, nominal speed	M_N	17.3 [152.9]	15.3 [135.8]	12.1 [107.1]	Nm [lb.in]
Maximum torque	M_{max}	73.4 [649.6]	73.4 [649.6]	73.4 [649.6]	Nm [lb.in]
Nominal speed	n_N	2000	3000	4000	rpm
Maximum speed	n_{max}	2773	4159	5199	rpm
Rated current, locked rotor	I_0	7.2	10.8	13.2	Arms
Peak current	I_p	32	48	60	Arms
Power yield in continuous service at nominal speed	P_N	3.6 [4.85]	4.8 [6.46]	5.1 [6.80]	kW [hp]
Torque constant	k_T	2.67 [23.6]	1.78 [15.7]	1.42 [12.6]	Nm/Arms [lb-in/Arms]
Voltage constant	k_e	165.9	110.6	88.5	Vrms/krpm
Thermal time constant	τ_{Th}	1400	1400	1400	sec
Resistance between the phases at 25°C	R_{tt}	2.44	1.08	0.73	Ohm
Inductance between the phases	L_{tt}	24.3	10.8	6.9	mH
Moment of rotor inertia	J	21.7 [192.1]	21.7 [192.1]	21.7 [192.1]	kgcm ² [lb-in.sec ² x 10 ⁻⁴]
Weight (without brake)	m	16.0 [35.3]	16.0 [35.3]	16.0 [35.3]	kg [lb]
Recommended cable section (4x)	S	1.5	1.5	1.5	mm ²
Recommended terminal type	-	Connector Size 1	Connector Size 1	Connector Size 1	-

Optional Holding Brake		Unit
Static braking torque (at 120°C)	22 [194.7]	Nm [lb.in]
Additional weight	1.5 [3.3]	kg [lb]
Additional inertia	3 [26.6]	kgcm ² [lb-in.sec ² x 10 ⁻⁴]
Power	19	Watt
Power supply voltage (+6 - 10%)	24	VDC

Notes:

- motor performance levels measured with Moog drives of the appropriate size
- performance in continuous service with $\Delta\theta$ winding = 105°C
- number of motor poles: 6
- DC Link voltage 565V

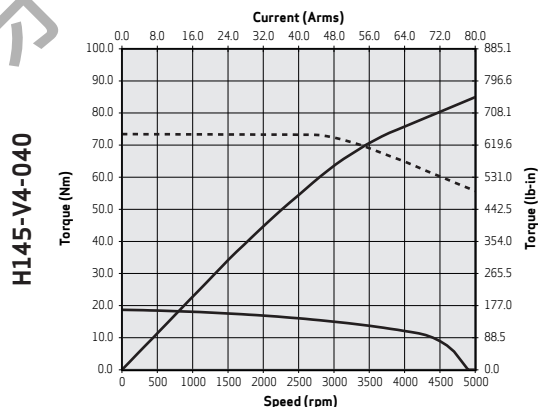
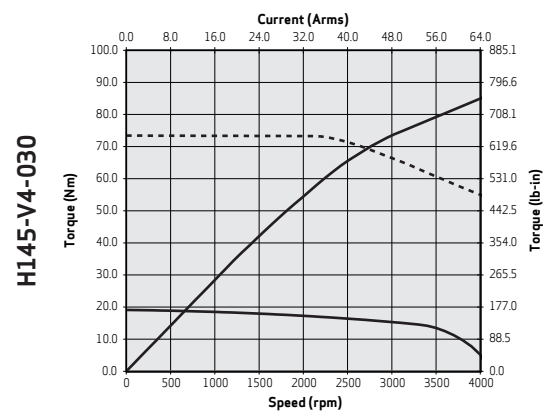
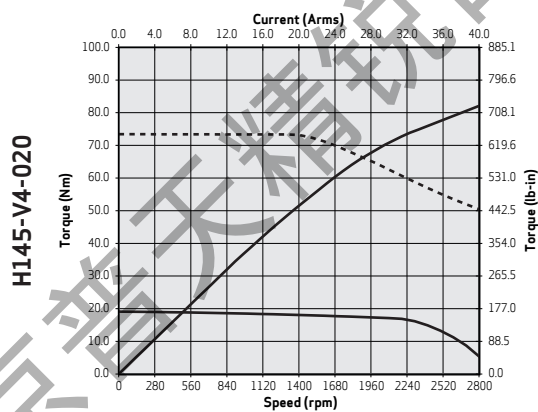

Size H145 - Natural cooling					
Characteristics and nominal values with sinusoidal drives					
Size		H145-V6-020	H145-V6-030	H145-V6-040	Units
Nominal torque, continuous service, locked rotor	M_0	26.6[235.3]	26.9[238.0]	26.6[235.3]	Nm [lb.in]
Nominal torque, continuous service, nominal speed	M_N	23.0[203.6]	19.4[171.6]	12.4[109.7]	Nm [lb.in]
Maximum torque	M_{max}	110.1[974.7]	110.1[974.7]	110.1[974.7]	Nm [lb.in]
Nominal speed	n_N	2000	3000	4000	rpm
Maximum speed	n_{max}	2773	3961	5546	rpm
Rated current, locked rotor	I_0	10.0	14.4	20	Arms
Peak current	I_p	48.0	68.6	96	Arms
Power yield in continuous service at nominal speed	P_N	4.8[6.46]	6.1 [8.17]	5.2[6.96]	kW [hp]
Torque constant	k_T	2.67[23.6]	1.87[16.5]	1.33[11.8]	Nm/Arms [lb-in/Arms]
Voltage constant	k_e	165.9	116.1	82.9	Vrms/krpm
Thermal time constant	τ_{Th}	1550	1550	1550	sec
Resistance between the phases at 25°C	R_{tt}	1.39	0.66	0.35	Ohm
Inductance between the phases	L_{tt}	15.4	7.5	3.8	mH
Moment of rotor inertia	J	32.2[285.0]	32.2[285.0]	32.2[285.0]	kgcm ² [lb-in.sec ² x 10 ⁻⁴]
Weight (without brake)	m	21.0[46.3]	21.0[46.3]	21.0[46.3]	kg [lb]
Recommended cable section (4x)	S	1.5	1.5	2.5	mm ²
Recommended terminal type	-	Connector Size 1	Connector Size 1	Connector Size 1	-

Optional Holding Brake		Unit
Static braking torque (at 120°C)	22[194.7]	Nm [lb.in]
Additional weight	1.5 [3.3]	kg [lb]
Additional inertia	3[26.6]	kgcm ² [lb-in.sec ² x 10 ⁻⁴]
Power	19	Watt
Power supply voltage (+6 - 10%)	24	VDC

Notes:

- motor performance levels measured with Moog drives of the appropriate size
- performance in continuous service with $\Delta\theta$ winding = 105°C
- number of motor poles: 6
- DC Link voltage 565V

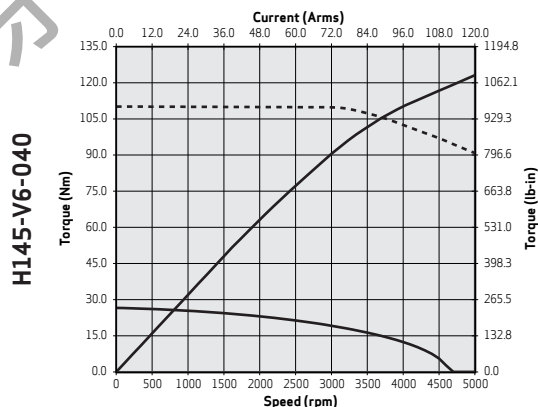
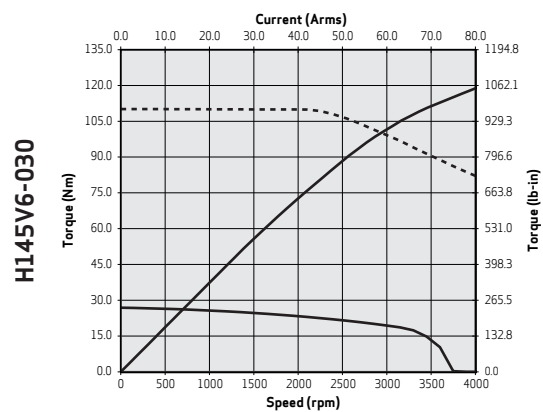
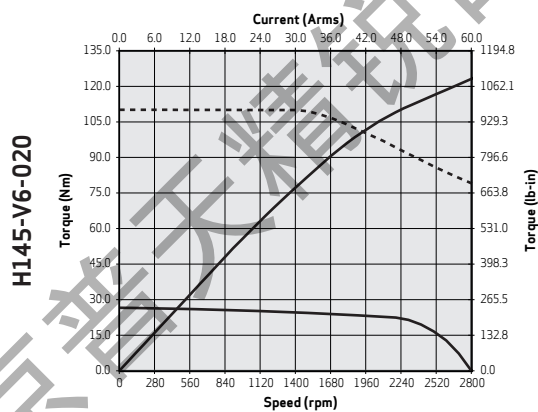

Size H145 - Natural cooling					
Characteristics and nominal values with sinusoidal drives					
Size		H145-V8-020	H145-V8-030	H145-V8-040	Units
Nominal torque, continuous service, locked rotor	M_0	33.5 [296.6]	32.7 [289.0]	33.5 [296.6]	Nm [lb.in]
Nominal torque, continuous service, nominal speed	M_N	28.0 [247.8]	21.0 [185.9]	7.7 [68.2]	Nm [lb.in]
Maximum torque	M_{max}	146.8 [1299.3]	146.8 [1299.3]	146.8 [1299.3]	Nm [lb.in]
Nominal speed	n_N	2000	3000	4000	rpm
Maximum speed	n_{max}	2773	4159	5199	rpm
Rated current, locked rotor	I_0	12.6	18.4	23.6	Arms
Peak current	I_p	64	96	120	Arms
Power yield in continuous service at nominal speed	P_N	5.9 [7.86]	6.6 [8.85]	3.2 [4.32]	kW [hp]
Torque constant	k_T	2.67 [23.6]	1.78 [15.7]	1.42 [12.6]	Nm/Arms [lb-in/Arms]
Voltage constant	k_e	165.9	110.6	88.5	Vrms/krpm
Thermal time constant	τ_{Th}	1700	1700	1700	sec
Resistance between the phases at 25°C	R_{tt}	0.95	0.44	0.27	Ohm
Inductance between the phases	L_{tt}	11.3	5.0	3.2	mH
Moment of rotor inertia	J	42.7 [377.9]	42.7 [377.9]	42.7 [377.9]	kgcm ² [lb-in.sec ² x 10 ⁻⁴]
Weight (without brake)	m	26.0 [57.3]	26.0 [57.3]	26.0 [57.3]	kg [lb]
Recommended cable section (4x)	S	1.5	2.5	4.0	mm ²
Recommended terminal type	-	Connector Size 1	Connector Size 1	Connector Size 1	-

Optional Holding Brake		Unit
Static braking torque (at 120°C)	22 [194.7]	Nm [lb.in]
Additional weight	1.5 [3.3]	kg [lb]
Additional inertia	3 [26.6]	kgcm ² [lb-in.sec ² x 10 ⁻⁴]
Power	19	Watt
Power supply voltage (+6 - 10%)	24	VDC

Notes:

- motor performance levels measured with Moog drives of the appropriate size
- performance in continuous service with $\Delta\theta$ winding = 105°C
- number of motor poles: 6
- DC Link voltage 565V
- handbrake available upon request

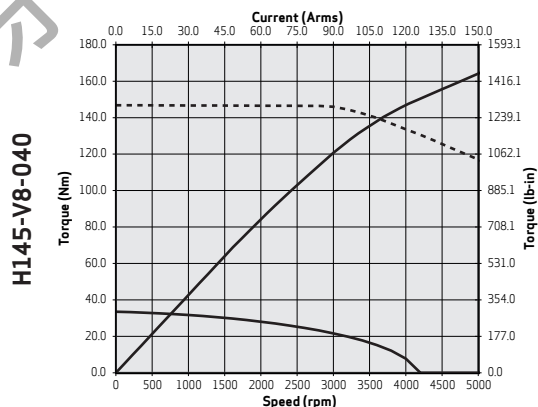
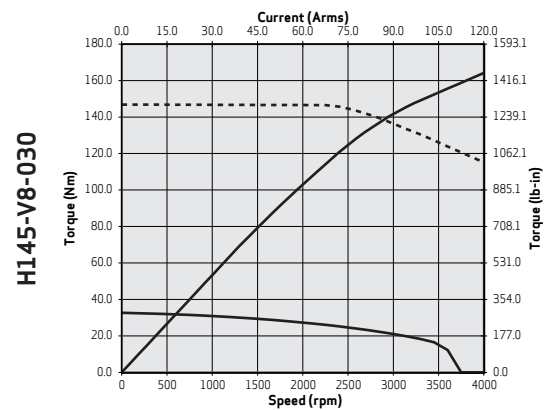
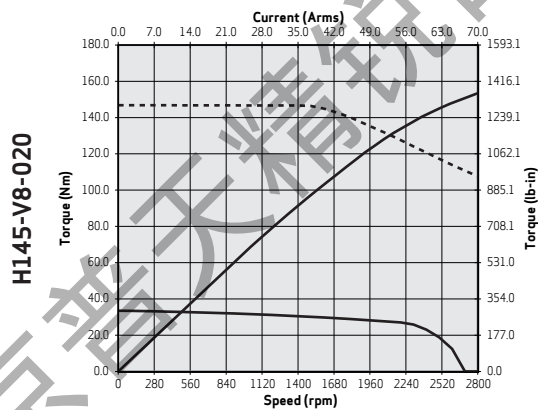

Size H200 - Natural cooling					
Characteristics and nominal values with sinusoidal drives					
Size		H200-V2-020	H200-V2-030	H200-V2-045	Units
Nominal torque, continuous service, locked rotor	M_0	34.0 [300.5]	33.1 [293.3]	34.0 [300.5]	Nm [lb.in]
Nominal torque, continuous service, nominal speed	M_N	29.20 [258.5]	24.08 [213.2]	11.09 [98.1]	Nm [lb.in]
Maximum torque	M_{max}	95 [840.8]	95 [840.8]	95 [840.8]	Nm [lb.in]
Nominal speed	n_N	2000	3000	4500	rpm
Maximum speed	n_{max}	3358	5036	6714	rpm
Rated current, locked rotor	I_0	15.3	22.3	30.5	Arms
Peak current	I_p	53	79.4	105.8	Arms
Power yield in continuous service at nominal speed	P_N	6.1 [8.20]	7.6 [10.14]	5.2 [7.00]	kW [hp]
Torque constant	k_T	2.22 [19.7]	1.48 [13.1]	1.11 [9.8]	Nm/Arms [lb-in/Arms]
Voltage constant	k_e	137.0	91.4	68.5	Vrms/krpm
Thermal time constant	τ_{Th}	1850	1850	1850	sec
Resistance between the phases at 25°C	R_{tt}	0.87	0.41	0.22	Ohm
Inductance between the phases	L_{tt}	11.4	5.0	2.8	mH
Moment of rotor inertia	J	93 [821.1]	93 [821.1]	93 [821.1]	kgcm ² [lb-in.sec ² x 10 ⁻⁴]
Weight (without brake)	m	28 [61.7]	28 [61.7]	28 [61.7]	kg [lb]
Recommended cable section (4x)	S	4	4	6	mm ²
Recommended terminal type	-	Connector Size 1.5	Connector Size 1.5	Connector Size 1.5	-

Optional Holding Brake		Unit
Static braking torque (at 120°C)	22 [194.7]	Nm [lb.in]
Additional weight	1.5 [3.3]	kg [lb]
Additional inertia	3 [26.6]	kgcm ² [lb-in.sec ² x 10 ⁻⁴]
Power	19	Watt
Power supply voltage (+6 - 10%)	24	VDC

Notes:

- motor performance levels measured with Moog drives of the appropriate size
- performance in continuous service with $\Delta\theta$ winding = 105°C
- number of motor poles: 6
- DC Link voltage 565V

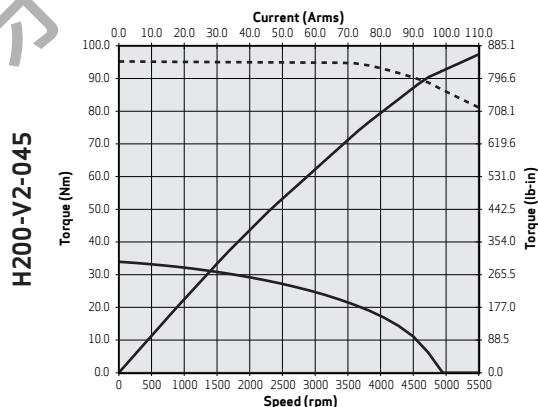
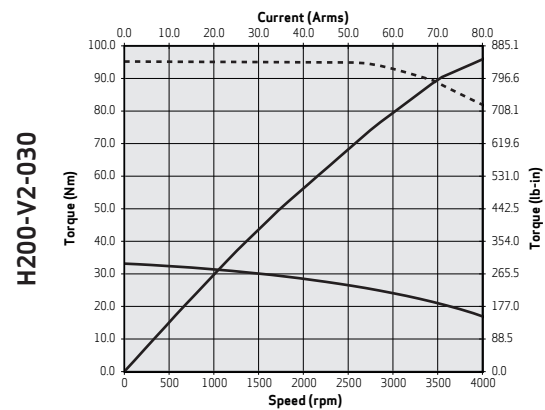
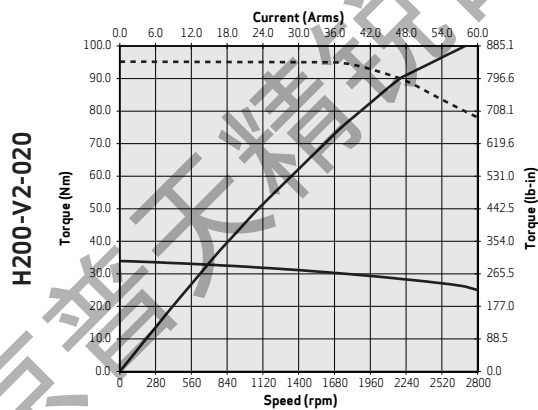

Size H200 - Natural cooling					
Characteristics and nominal values with sinusoidal drives					
Size		H200-P2-014	H200-P2-022	H200-P2-030	Units
Nominal torque, continuous service, locked rotor	M_0	45.2 [400.2]	45.5 [403.0]	45.8 [405.5]	Nm [lb.in]
Nominal torque, continuous service, nominal speed	M_N	38.80 [343.5]	32.60 [288.5]	22.30 [197.4]	Nm [lb.in]
Maximum torque	M_{max}	174 [1540.0]	174 [1540.0]	174 [1540.0]	Nm [lb.in]
Nominal speed	n_N	1400	2200	3000	rpm
Maximum speed	n_{max}	2099	2957	4066	rpm
Rated current, locked rotor	I_0	12.5	17.8	24.6	Arms
Peak current	I_p	62	87.3	120	Arms
Power yield in continuous service at nominal speed	P_N	5.7 [7.63]	7.5 [10.07]	7.0 [9.39]	kW [hp]
Torque constant	k_T	3.61 [32.0]	2.56 [22.7]	1.86 [16.5]	Nm/Arms [lb-in/Arms]
Voltage constant	k_e	219.2	155.5	113.1	Vrms/krpm
Thermal time constant	τ_{Th}	1850	1850	1850	sec
Resistance between the phases at 25°C	R_{tt}	1.30	0.64	0.34	Ohm
Inductance between the phases	L_{tt}	9.3	4.7	2.5	mH
Moment of rotor inertia	J	93 [821.1]	93 [821.1]	93 [821.1]	kgcm ² [lb-in.sec ² x 10 ⁻⁴]
Weight (without brake)	m	28 [61.7]	28 [61.7]	28 [61.7]	kg [lb]
Recommended cable section (4x)	S	4	4	4	mm ²
Recommended terminal type	-	Connector Size 1.5	Connector Size 1.5	Connector Size 1.5	-

Optional Holding Brake		Unit
Static braking torque (at 120°C)	22 [194.7]	Nm [lb.in]
Additional weight	1.5 [3.3]	kg [lb]
Additional inertia	3 [26.6]	kgcm ² [lb-in.sec ² x 10 ⁻⁴]
Power	19	Watt
Power supply voltage (+6 - 10%)	24	VDC

Notes:

- motor performance levels measured with Moog drives of the appropriate size
- performance in continuous service with $\Delta\theta$ winding = 105°C
- number of motor poles: 12
- DC Link voltage 565V

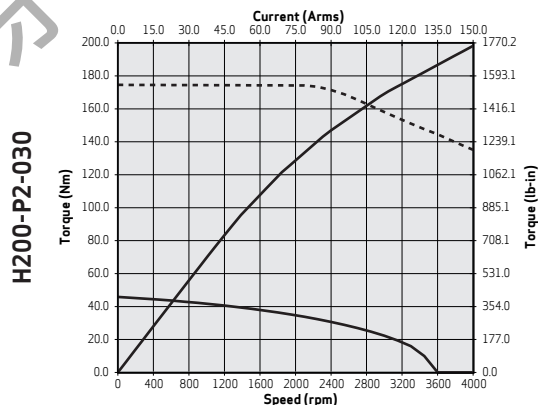
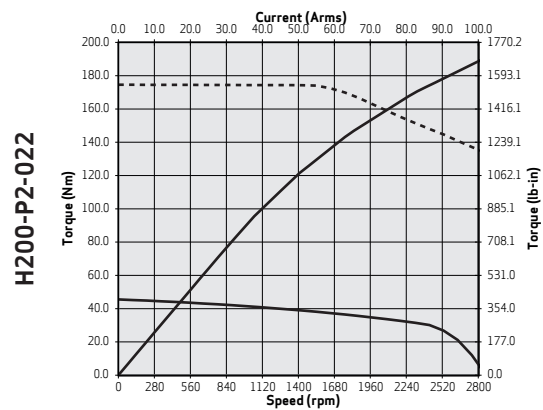
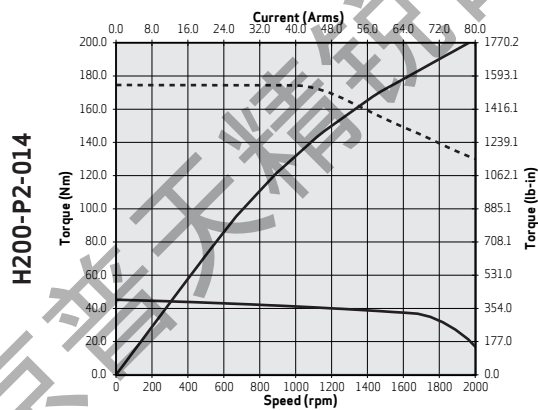

Size H200 - Natural cooling					
Characteristics and nominal values with sinusoidal drives					
Size		H200-V3-020	H200-V3-030	H200-V3-039	Units
Nominal torque, continuous service, locked rotor	M_0	47.9 [423.6]	49.0 [433.9]	47.9 [423.6]	Nm [lb.in]
Nominal torque, continuous service, nominal speed	M_N	38.38 [339.7]	29.07 [257.3]	6.73 [59.6]	Nm [lb.in]
Maximum torque	M_{max}	146 [1292.2]	146 [1292.2]	146 [1292.2]	Nm [lb.in]
Nominal speed	n_N	2000	3000	3900	rpm
Maximum speed	n_{max}	3283	4377	5252	rpm
Rated current, locked rotor	I_0	21.0	28.7	33.6	Arms
Peak current	I_p	79	106	127	Arms
Power yield in continuous service at nominal speed	P_N	8.0 [10.78]	9.1 [12.24]	2.7 [3.69]	kW [hp]
Torque constant	k_T	2.28 [20.2]	1.71 [15.1]	1.42 [12.6]	Nm/Arms [lb-in/Arms]
Voltage constant	k_e	140.1	105.1	87.6	Vrms/krpm
Thermal time constant	τ_{Th}	2050	2050	2050	sec
Resistance between the phases at 25°C	R_{tt}	0.51	0.27	0.20	Ohm
Inductance between the phases	L_{tt}	6.9	3.9	2.7	mH
Moment of rotor inertia	J	135 [1194.3]	135 [1194.3]	135 [1194.3]	kgcm ² [lb-in.sec ² x 10 ⁻⁴]
Weight (without brake)	m	36 [79.4]	36 [79.4]	36 [79.4]	kg [lb]
Recommended cable section (4x)	S	4	6	6	mm ²
Recommended terminal type	-	Connector Size 1.5	Connector Size 1.5	Connector Size 1.5	-

Optional Holding Brake		Unit
Static braking torque (at 120°C)	22 [194.7]	Nm [lb.in]
Additional weight	1.5 [3.3]	kg [lb]
Additional inertia	3 [26.6]	kgcm ² [lb-in.sec ² x 10 ⁻⁴]
Power	19	Watt
Power supply voltage (+6 - 10%)	24	VDC

Notes:

- motor performance levels measured with Moog drives of the appropriate size
- performance in continuous service with $\Delta\theta$ winding = 105°C
- number of motor poles: 6
- DC Link voltage 565V

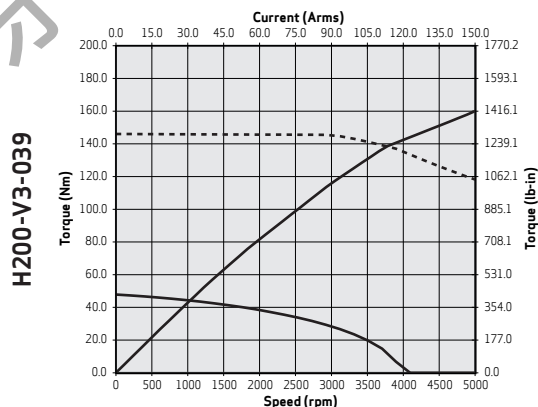
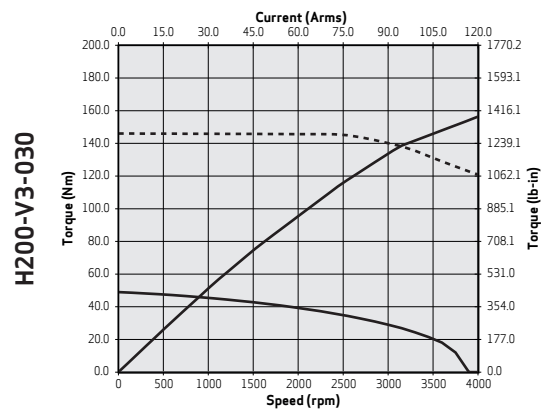
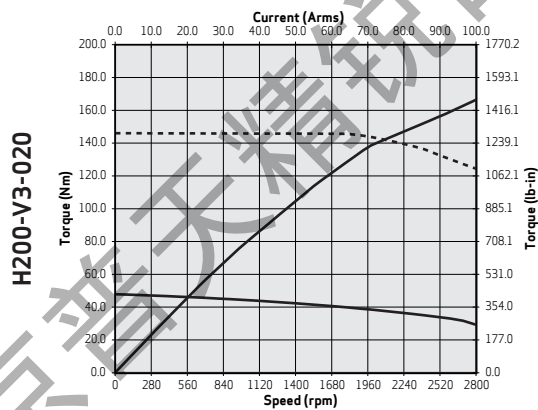

Size H200 - Natural cooling					
Characteristics and nominal values with sinusoidal drives					
Size		H200-P3-014	H200-P3-018	H200-P3-022	Units
Nominal torque, continuous service, locked rotor	M_0	65.0[575.7]	64.4[570.3]	63.4[560.9]	Nm [lb.in]
Nominal torque, continuous service, nominal speed	M_N	51.92[459.6]	45.20[400.1]	36.32[321.4]	Nm [lb.in]
Maximum torque	M_{max}	267[2363.2]	267[2363.2]	267[2363.2]	Nm [lb.in]
Nominal speed	n_N	1400	1800	2200	rpm
Maximum speed	n_{max}	2121	2356	2828	rpm
Rated current, locked rotor	I_0	18.2	20.0	23.6	Arms
Peak current	I_p	96	107	128	Arms
Power yield in continuous service at nominal speed	P_N	7.6[10.21]	8.5[11.42]	8.4[11.22]	kW [hp]
Torque constant	k_T	3.58[31.7]	3.22[28.5]	2.68[23.7]	Nm/Arms [lb-in/Arms]
Voltage constant	k_e	216.9	195.2	162.7	Vrms/krpm
Thermal time constant	τ_{Th}	2050	2050	2050	sec
Resistance between the phases at 25°C	R_{tt}	0.68	0.56	0.40	Ohm
Inductance between the phases	L_{tt}	5.8	4.7	3.3	mH
Moment of rotor inertia	J	135 [1194.3]	135 [1194.3]	135 [1194.3]	kgcm ² [lb-in.sec ² x 10 ⁻⁴]
Weight (without brake)	m	36 [79.4]	36 [79.4]	36 [79.4]	kg [lb]
Recommended cable section (4x)	S	4	4	4	mm ²
Recommended terminal type	-	Connector Size 1.5	Connector Size 1.5	Connector Size 1.5	-

Optional Holding Brake		Unit
Static braking torque (at 120°C)	22 [194.7]	Nm [lb.in]
Additional weight	1.5 [3.3]	kg [lb]
Additional inertia	3 [26.6]	kgcm ² [lb-in.sec ² x 10 ⁻⁴]
Power	19	Watt
Power supply voltage (+6 - 10%)	24	VDC

Notes:

- motor performance levels measured with Moog drives of the appropriate size
- performance in continuous service with $\Delta\theta$ winding = 105°C
- number of motor poles: 12
- DC Link voltage 565V

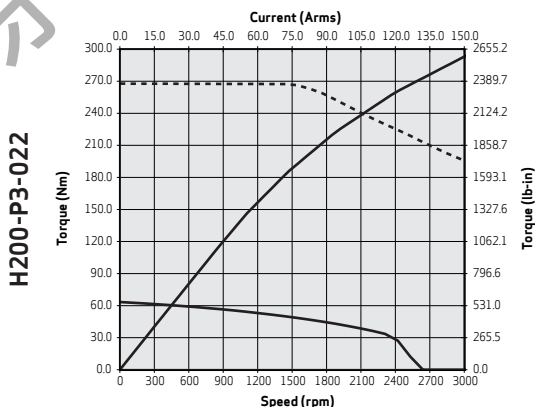
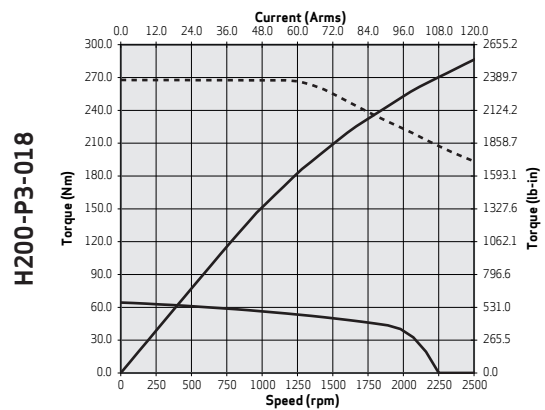
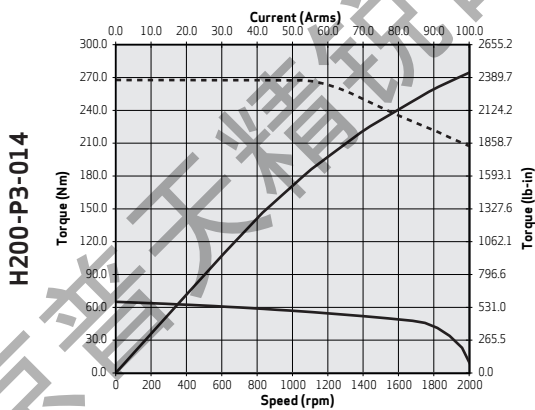

Size H200 - Natural cooling					
Characteristics and nominal values with sinusoidal drives					
Size		H200-V4-014	H200-V4-020	H200-V4-030	Units
Nominal torque, continuous service, locked rotor	M_0	63.2[559.2]	63.4[560.8]	62.1[549.3]	Nm [lb.in]
Nominal torque, continuous service, nominal speed	M_N	54.11[478.9]	43.26[382.9]	27.79[246.0]	Nm [lb.in]
Maximum torque	M_{max}	196[1734.7]	196[1734.7]	196[1734.7]	Nm [lb.in]
Nominal speed	n_N	1400	2000	3000	rpm
Maximum speed	n_{max}	1855	2997	4329	rpm
Rated current, locked rotor	I_0	15.7	25.4	35.9	Arms
Peak current	I_p	61	97.7	141.1	Arms
Power yield in continuous service at nominal speed	P_N	7.9[10.64]	9.1[12.15]	8.7[11.71]	kW [hp]
Torque constant	k_T	4.03[35.7]	2.50[22.1]	1.73[15.3]	Nm/Arms [lb-in/Arms]
Voltage constant	k_e	247.9	153.5	106.3	Vrms/krpm
Thermal time constant	τ_{Th}	2270	2270	2270	sec
Resistance between the phases at 25°C	R_{tt}	1.00	0.38	0.19	Ohm
Inductance between the phases	L_{tt}	15.0	5.8	2.8	mH
Moment of rotor inertia	J	177[1567.5]	177[1567.5]	177[1567.5]	kgcm ² [lb-in.sec ² x 10 ⁻⁴]
Weight (without brake)	m	44[97.0]	44[97.0]	44[97.0]	kg [lb]
Recommended cable section (4x)	S	4	4	6	mm ²
Recommended terminal type	-	Connector Size 1.5	Connector Size 1.5	Connector Size 1.5	-

Optional Holding Brake		Unit
Static braking torque (at 120°C)	80[708.1]	Nm [lb.in]
Additional weight	5[11.0]	kg [lb]
Additional inertia	27[239.0]	kgcm ² [lb-in.sec ² x 10 ⁻⁴]
Power	36.5	Watt
Power supply voltage (+6 - 10%)	24	VDC

Notes:

- motor performance levels measured with Moog drives of the appropriate size
- performance in continuous service with $\Delta\theta$ winding = 105°C
- number of motor poles: 6
- DC Link voltage 565V

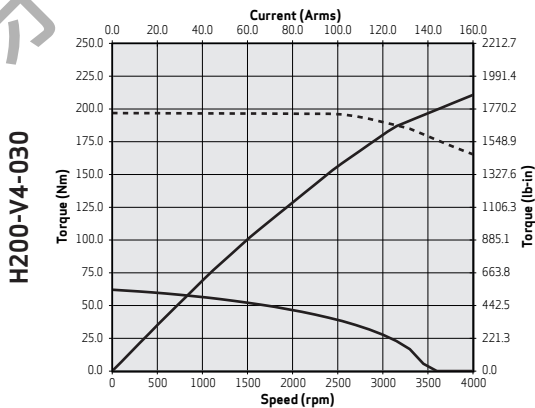
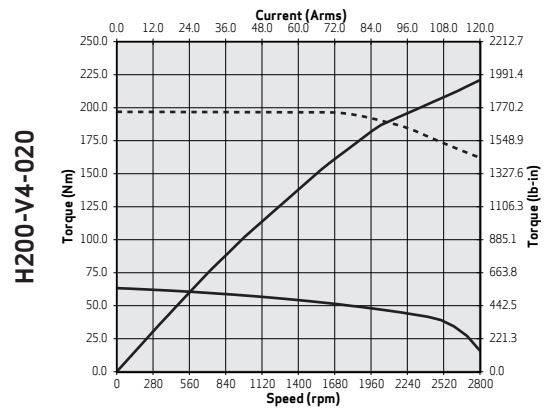
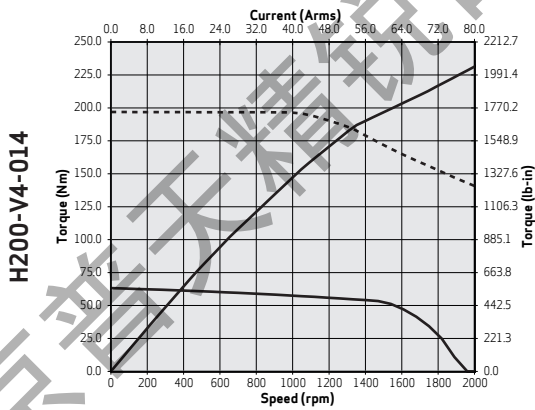

Size H200 - Natural cooling					
Characteristics and nominal values with sinusoidal drives					
Size		H200-P4-014	H200-P4-018	H200-P4-020	Units
Nominal torque, continuous service, locked rotor	M_0	82.5 [729.8]	81.8 [724.1]	81.8 [724.1]	Nm [lb.in]
Nominal torque, continuous service, nominal speed	M_N	61.40 [543.4]	50.23 [444.6]	43.24 [382.7]	Nm [lb.in]
Maximum torque	M_{max}	360 [3186.3]	360 [3186.3]	360 [3186.3]	Nm [lb.in]
Nominal speed	n_N	1400	1800	2000	rpm
Maximum speed	n_{max}	1748	2247	2622	rpm
Rated current, locked rotor	I_0	19.0	24.2	28.3	Arms
Peak current	I_p	107	137.1	160	Arms
Power yield in continuous service at nominal speed	P_N	9.0 [12.07]	9.5 [12.70]	9.1 [12.14]	kW [hp]
Torque constant	k_T	4.34 [38.4]	3.38 [29.9]	2.89 [25.6]	Nm/Arms [lb-in/Arms]
Voltage constant	k_e	263.2	204.7	175.4	Vrms/krpm
Thermal time constant	τ_{Th}	2270	2270	2270	sec
Resistance between the phases at 25°C	R_{tt}	0.68	0.42	0.31	Ohm
Inductance between the phases	L_{tt}	6.3	3.8	2.8	mH
Moment of rotor inertia	J	177 [1567.5]	177 [1567.5]	177 [1567.5]	kgcm ² [lb-in.sec ² x 10 ⁻⁴]
Weight (without brake)	m	44 [97.0]	44 [97.0]	44 [97.0]	kg [lb]
Recommended cable section (4x)	S	4	4	6	mm ²
Recommended terminal type	-	Connector Size 1.5	Connector Size 1.5	Connector Size 1.5	-

Optional Holding Brake		Unit
Static braking torque (at 120°C)	80 [708.1]	Nm [lb.in]
Additional weight	5 [11.0]	kg [lb]
Additional inertia	27 [239.0]	kgcm ² [lb-in.sec ² x 10 ⁻⁴]
Power	36.5	Watt
Power supply voltage (+6 - 10%)	24	VDC

Notes:

- motor performance levels measured with Moog drives of the appropriate size
- performance in continuous service with $\Delta\theta$ winding = 105°C
- number of motor poles: 12
- DC Link voltage 565V

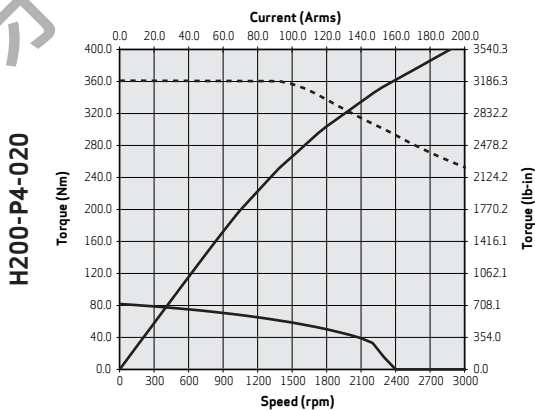
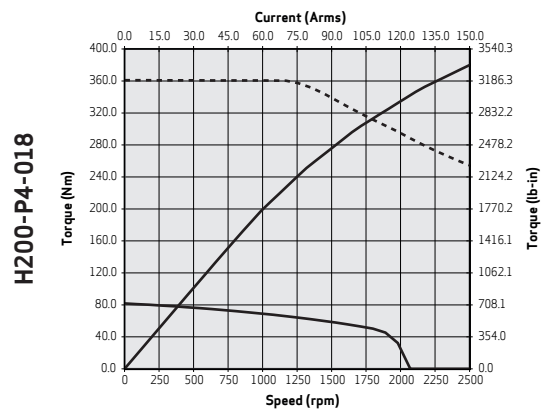
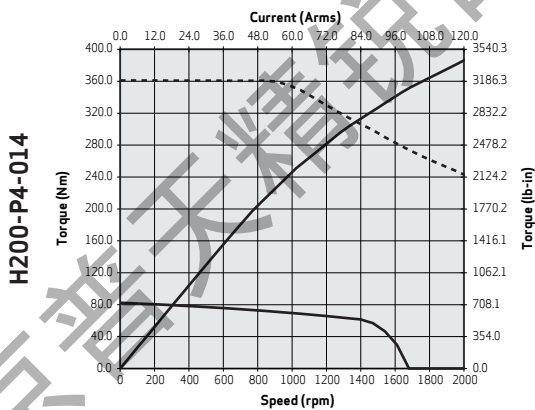

Size H200 - Natural cooling					
Characteristics and nominal values with sinusoidal drives					
Size		H200-V6-012	H200-V6-020	H200-V6-025	Units
Nominal torque, continuous service, locked rotor	M_0	89.7 [794.1]	87.6 [775.3]	87.6 [775.3]	Nm [lb.in]
Nominal torque, continuous service, nominal speed	M_N	76.23 [674.7]	58.09 [514.1]	40.94 [362.3]	Nm [lb.in]
Maximum torque	M_{max}	297 [2628.7]	297 [2628.7]	297 [2628.7]	Nm [lb.in]
Nominal speed	n_N	1200	2000	2500	rpm
Maximum speed	n_{max}	1842	2578	3223	rpm
Rated current, locked rotor	I_0	22.1	30.1	37.6	Arms
Peak current	I_p	91	127	159	Arms
Power yield in continuous service at nominal speed	P_N	9.6 [12.84]	12.2 [16.31]	10.7 [14.37]	kW [hp]
Torque constant	k_T	4.07 [36.0]	2.91 [25.7]	2.33 [20.6]	Nm/Arms [lb-in/Arms]
Voltage constant	k_e	249.8	178.4	142.7	Vrms/krpm
Thermal time constant	τ_{Th}	2550	2550	2550	sec
Resistance between the phases at 25°C	R_{tt}	0.59	0.32	0.20	Ohm
Inductance between the phases	L_{tt}	9.5	4.8	3.1	mH
Moment of rotor inertia	J	261 [2306.4]	261 [2306.4]	261 [2306.4]	kgcm ² [lb-in.sec ² x 10 ⁻⁴]
Weight (without brake)	m	60 [132.3]	60 [132.3]	60 [132.3]	kg [lb]
Recommended cable section (4x)	S	4	6	10	mm ²
Recommended terminal type	-	Connector Size 1.5	Connector Size 1.5	Connector Size 1.5	-

Optional Holding Brake		Unit
Static braking torque (at 120°C)	80 [708.1]	Nm [lb.in]
Additional weight	5 [11.0]	kg [lb]
Additional inertia	27 [239.0]	kgcm ² [lb-in.sec ² x 10 ⁻⁴]
Power	36.5	Watt
Power supply voltage (+6 - 10%)	24	VDC

Notes:

- motor performance levels measured with Moog drives of the appropriate size
- performance in continuous service with $\Delta\theta$ winding = 105°C
- number of motor poles: 6
- DC Link voltage 565V

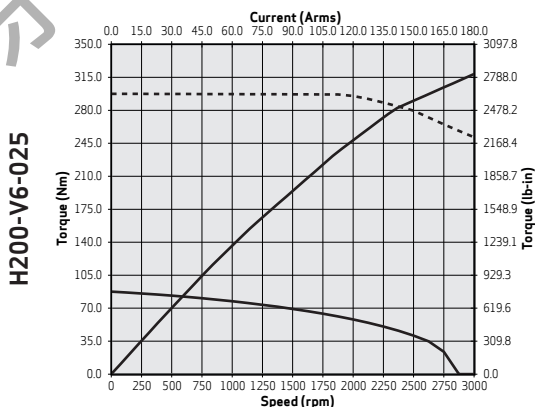
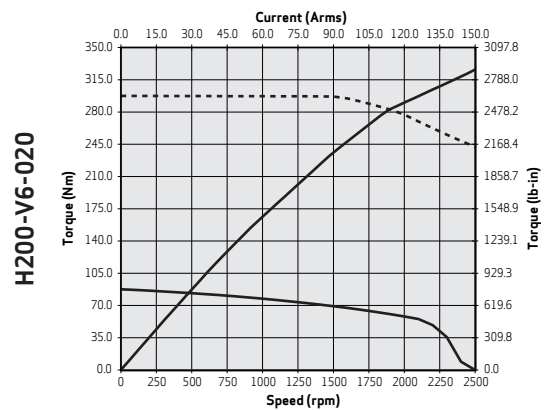
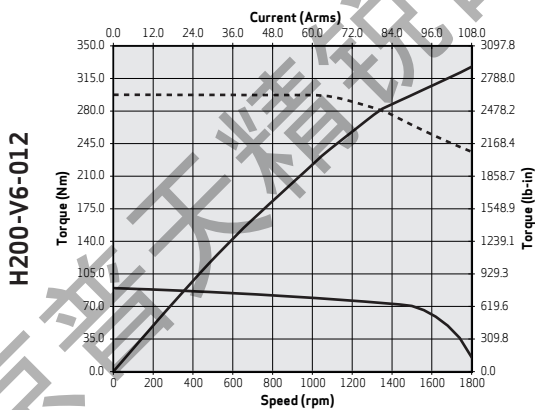

Size H200 - Natural cooling					
Characteristics and nominal values with sinusoidal drives					
Size		H200-P6-011	H200-P6-015	H200-P6-018	Units
Nominal torque, continuous service, locked rotor	M_0	114.1 [1009.8]	117.8 [1042.9]	116.1 [1027.9]	Nm [lb.in]
Nominal torque, continuous service, nominal speed	M_N	86.99 [770.0]	72.07 [637.9]	51.83 [458.7]	Nm [lb.in]
Maximum torque	M_{max}	545 [4823.7]	545 [4823.7]	545 [4823.7]	Nm [lb.in]
Nominal speed	n_N	1100	1500	1800	rpm
Maximum speed	n_{max}	1388	1893	2313	rpm
Rated current, locked rotor	I_0	20.9	29.4	35.4	Arms
Peak current	I_p	128	175	213	Arms
Power yield in continuous service at nominal speed	P_N	10.0 [13.44]	11.3 [15.18]	9.8 [13.10]	kW [hp]
Torque constant	k_T	5.47 [48.4]	4.00 [35.4]	3.28 [29.0]	Nm/Arms [lb-in/Arms]
Voltage constant	k_e	331.4	243.0	198.8	Vrms/krpm
Thermal time constant	τ_{Th}	2550	2550	2550	sec
Resistance between the phases at 25°C	R_{tt}	0.66	0.33	0.23	Ohm
Inductance between the phases	L_{tt}	6.6	3.5	2.4	mH
Moment of rotor inertia	J	261 [2306.4]	261 [2306.4]	261 [2306.4]	kgcm ² [lb-in.sec ² x 10 ⁻⁴]
Weight (without brake)	m	60 [132.3]	60 [132.3]	60 [132.3]	kg [lb]
Recommended cable section (4x)	S	4	6	6	mm ²
Recommended terminal type	-	Connector Size 1.5	Connector Size 1.5	Connector Size 1.5	-

Optional Holding Brake		Unit
Static braking torque (at 120°C)	80 [708.1]	Nm [lb.in]
Additional weight	5 [11.0]	kg [lb]
Additional inertia	27 [239.0]	kgcm ² [lb-in.sec ² x 10 ⁻⁴]
Power	36.5	Watt
Power supply voltage (+6 - 10%)	24	VDC

Notes:

- motor performance levels measured with Moog drives of the appropriate size
- performance in continuous service with $\Delta\theta$ winding = 105°C
- number of motor poles: 12
- DC Link voltage 565V

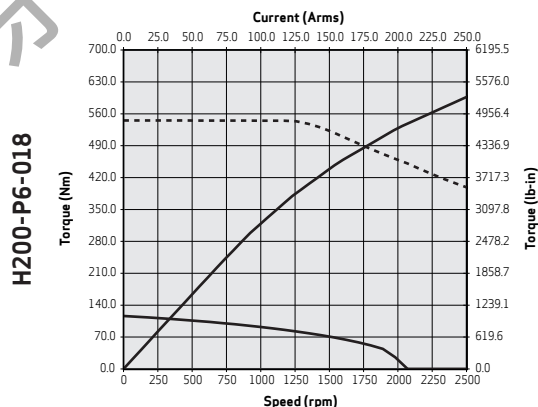
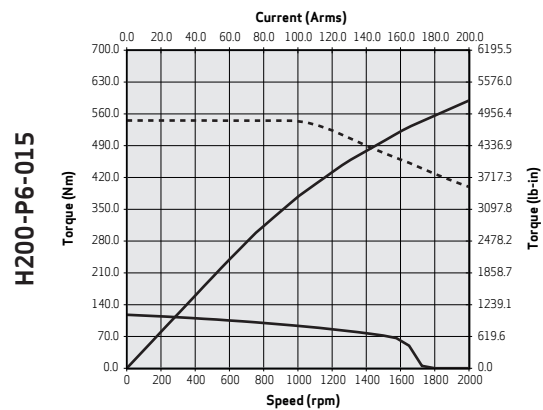
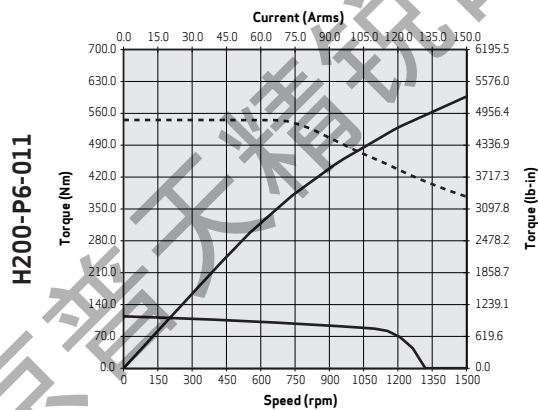

Size H200 - Natural cooling					
Characteristics and nominal values with sinusoidal drives					
Size		H200-V8-012	H200-V8-016	H200-V8-020	Units
Nominal torque, continuous service, locked rotor	M_0	114.1 [1010.0]	113.1 [1001.1]	115.2 [1019.2]	Nm [lb.in]
Nominal torque, continuous service, nominal speed	M_N	93.86 [830.7]	81.82 [724.1]	67.63 [598.5]	Nm [lb.in]
Maximum torque	M_{max}	398 [3522.6]	398 [3522.6]	398 [3522.6]	Nm [lb.in]
Nominal speed	n_N	1200	1600	2000	rpm
Maximum speed	n_{max}	1752	2141	2753	rpm
Rated current, locked rotor	I_0	26.6	32.3	42.3	Arms
Peak current	I_p	116	141	181	Arms
Power yield in continuous service at nominal speed	P_N	11.8 [15.81]	13.7 [18.38]	14.2 [18.99]	kW [hp]
Torque constant	k_T	4.28 [37.9]	3.51 [31.0]	2.73 [24.1]	Nm/Arms [lb-in/Arms]
Voltage constant	k_e	262.6	214.9	167.1	Vrms/krpm
Thermal time constant	τ_{Th}	3050	3050	3050	sec
Resistance between the phases at 25°C	R_{tt}	0.46	0.32	0.18	Ohm
Inductance between the phases	L_{tt}	7.6	5.1	3.1	mH
Moment of rotor inertia	J	344 [3044.7]	344 [3044.7]	344 [3044.7]	kgcm ² [lb-in.sec ² x 10 ⁻⁴]
Weight (without brake)	m	76 [167.6]	76 [167.6]	76 [167.6]	kg [lb]
Recommended cable section (4x)	S	4	6	10	mm ²
Recommended terminal type	-	Connector Size 1.5	Connector Size 1.5	Connector Size 1.5	-

Optional Holding Brake		Unit
Static braking torque (at 120°C)	80 [708.1]	Nm [lb.in]
Additional weight	5 [11.0]	kg [lb]
Additional inertia	27 [239.0]	kgcm ² [lb-in.sec ² x 10 ⁻⁴]
Power	36.5	Watt
Power supply voltage (+6 - 10%)	24	VDC

Notes:

- motor performance levels measured with Moog drives of the appropriate size
- performance in continuous service with $\Delta\theta$ winding = 105°C
- number of motor poles: 6
- DC Link voltage 565V
- handbrake available upon request

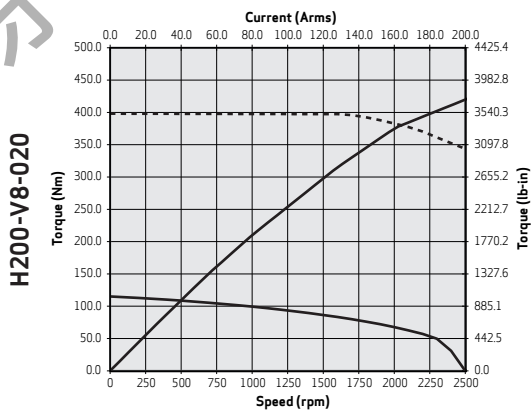
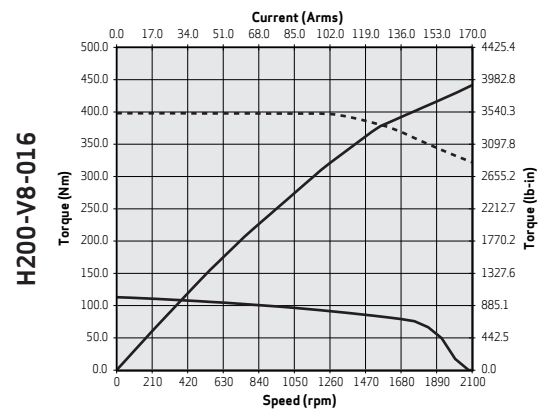
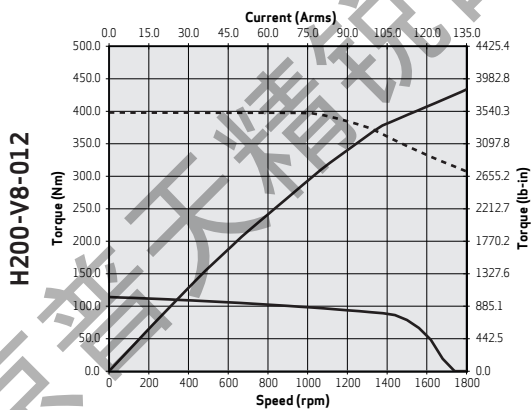

Size H200 - Natural cooling					
Characteristics and nominal values with sinusoidal drives					
Size		H200-P8-008	H200-P8-010	H200-P8-014	Units
Nominal torque, continuous service, locked rotor	M_0	146.9 [1300.4]	146.9 [1300.4]	148.2 [1311.9]	Nm [lb.in]
Nominal torque, continuous service, nominal speed	M_N	120.38 [1065.5]	110.68 [979.6]	85.65 [758.0]	Nm [lb.in]
Maximum torque	M_{max}	725 [6416.8]	725 [6416.8]	725 [6416.8]	Nm [lb.in]
Nominal speed	n_N	800	1000	1400	rpm
Maximum speed	n_{max}	1111	1297	1729	rpm
Rated current, locked rotor	I_0	21.5	25.1	33.8	Arms
Peak current	I_p	137	160	213	Arms
Power yield in continuous service at nominal speed	P_N	10.1 [13.52]	11.6 [15.54]	12.6 [16.84]	kW [hp]
Torque constant	k_T	6.83 [60.4]	5.85 [51.8]	4.39 [38.8]	Nm/Arms [lb.in/Arms]
Voltage constant	k_e	413.9	354.7	266.1	Vrms/krpm
Thermal time constant	τ_{Th}	3050	3050	3050	sec
Resistance between the phases at 25°C	R_{tt}	0.71	0.52	0.29	Ohm
Inductance between the phases	L_{tt}	7.6	5.6	3.1	mH
Moment of rotor inertia	J	344 [3044.7]	344 [3044.7]	344 [3044.7]	kgcm ² [lb.in.sec ² x 10 ⁻⁴]
Weight (without brake)	m	76 [167.6]	76 [167.6]	76 [167.6]	kg [lb]
Recommended cable section (4x)	S	4	4	6	mm ²
Recommended terminal type	-	Connector Size 1.5	Connector Size 1.5	Connector Size 1.5	-

Optional Holding Brake		Unit
Static braking torque (at 120°C)	80 [708.1]	Nm [lb.in]
Additional weight	5 [11.0]	kg [lb]
Additional inertia	27 [239.0]	kgcm ² [lb.in.sec ² x 10 ⁻⁴]
Power	36.5	Watt
Power supply voltage (+6 - 10%)	24	VDC

Notes:

- motor performance levels measured with Moog drives of the appropriate size
- performance in continuous service with $\Delta\theta$ winding = 105°C
- number of motor poles: 12
- DC Link voltage 565V
- handbrake available upon request

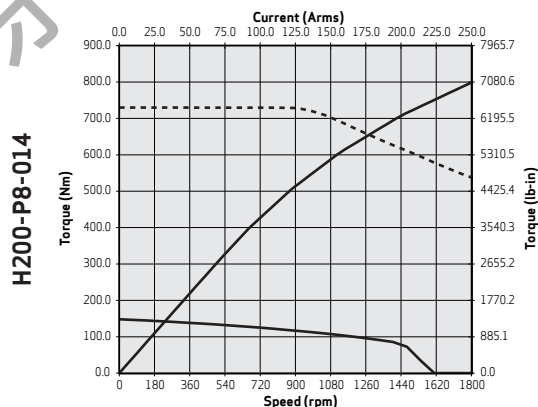
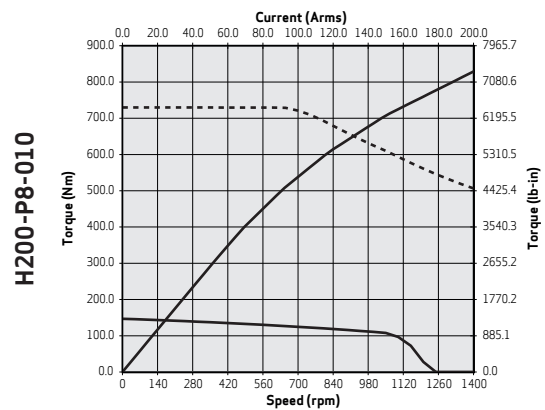
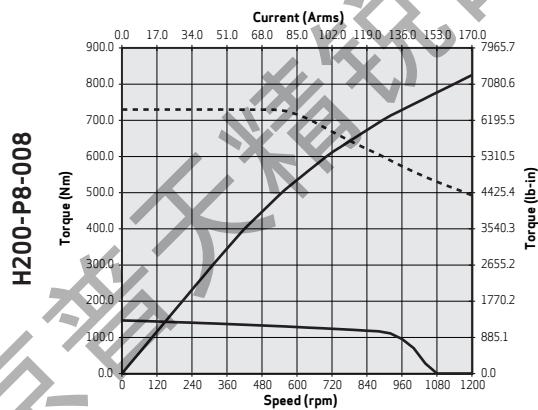

Size H275 - Natural cooling						
Characteristics and nominal values with sinusoidal drives						
Size		H275-V3-012	H275-V4-010	H275-V4-015	H275-V5-010	Units
Nominal torque, continuous service, locked rotor	M_o	192.0 [1699.3]	260.0 [2301.2]	260.0 [2301.2]	328.0 [2903.0]	Nm [lb.in]
Nominal torque, continuous service, nominal speed	M_N	138.5 [1226.1]	200.6 [1775.2]	118.6 [1049.4]	246.7 [2183.2]	Nm [lb.in]
Maximum torque	M_{max}	455 [4027.1]	617 [5460.9]	617 [5460.9]	781 [6912.4]	Nm [lb.in]
Nominal speed	n_N	1200	1000	1500	1000	rpm
Maximum speed	n_{max}	1658	1392	1740	1269	rpm
Rated current, locked rotor	I_o	41.7	47.5	59.4	54.6	Arms
Peak current	I_p	111	126	157.5	145	Arms
Power yield in continuous service at nominal speed	P_N	17.4 [23.34]	21.0 [28.16]	18.6 [24.97]	25.8 [34.63]	kW [hp]
Torque constant	k_T	4.60 [40.7]	5.47 [48.4]	4.38 [38.8]	6.00 [53.1]	Nm/Arms [lb-in/Arms]
Voltage constant	k_e	277.5	330.5	264.4	362.4	Vrms/krpm
Thermal time constant	τ_{Th}	5200	6000	6000	6800	sec
Resistance between the phases at 25°C	R_{tt}	0.16	0.15	0.09	0.13	Ohm
Inductance between the phases	L_{tt}	4.9	5.1	3.3	4.8	mH
Moment of rotor inertia	J	687 [6080.5]	919 [8133.8]	919 [8133.8]	1156 [10231.5]	kgcm ² [lb-in.sec ² x 10 ⁻⁴]
Weight (without brake)	m	104 [229.3]	130 [286.6]	130 [286.6]	157 [346.1]	kg [lb]
Recommended cable section (4x)	S	10	10	16	16	mm ²
Recommended terminal type	-	Connector Size 1.5	Connector Size 1.5	Connector Size 1.5	Connector Size 1.5	-

Notes:

- motor performance levels measured with Moog drives of the appropriate size
- performance in continuous service with $\Delta\theta$ winding = 105°C
- number of motor poles: 8
- DC Link voltage 565V
- handbrake available upon request
- personalised windings available upon request

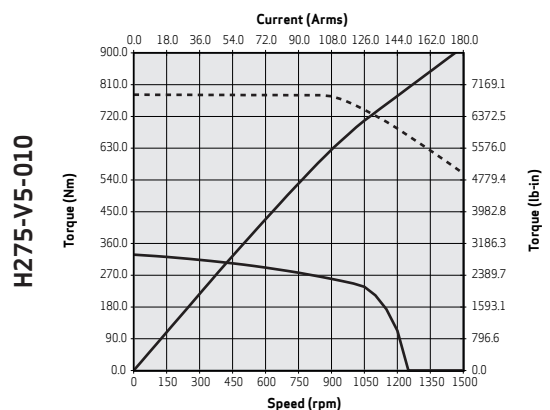
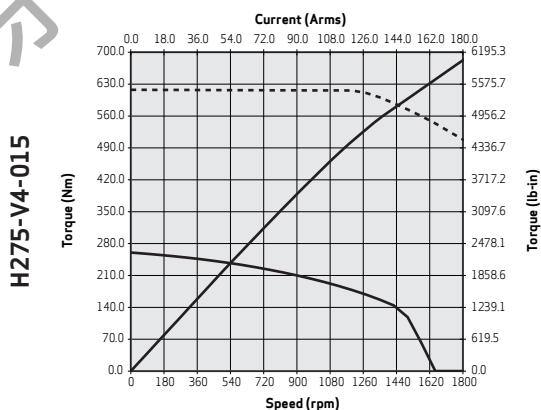
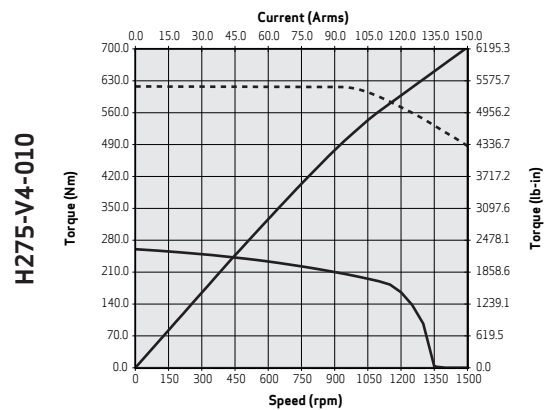
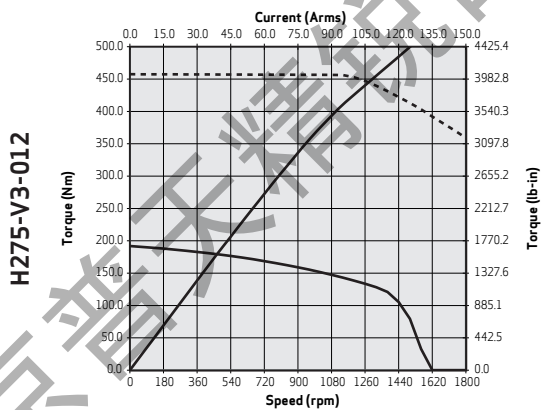

Size WH100 - Liquid cooling					
Characteristics and nominal values with sinusoidal drives					
Size		WH100-V2-030	WH100-V2-045	WH100-V2-060	Units
Nominal torque, continuous service, locked rotor	M_0	5.42 [48.0]	5.54 [49.0]	5.49 [48.6]	Nm [lb.in]
Nominal torque, continuous service, nominal speed	M_N	5.30 [46.9]	5.34 [47.3]	5.20 [46.0]	Nm [lb.in]
Maximum torque	M_{max}	12.5 [110.6]	12.5 [110.6]	12.5 [110.6]	Nm [lb.in]
Nominal speed	n_N	3000	4500	6000	rpm
Maximum speed	n_{max}	4488	7431	8736	rpm
Rated current, locked rotor	I_0	3.45	5.9	6.8	Arms
Peak current	I_p	10	16	19	Arms
Power yield in continuous service at nominal speed	P_N	1.67 [2.23]	2.52 [3.38]	3.27 [4.38]	kW [hp]
Torque constant	k_T	1.57 [13.9]	0.95 [8.4]	0.81 [7.1]	Nm/Arms [lb.in./Arms]
Voltage constant	k_e	102.5	61.9	52.7	Vrms/krpm
Thermal time constant	τ_{Th}	440	440	440	sec
Resistance between the phases at 25°C	R_{tt}	16.16	5.64	4.15	Ohm
Inductance between the phases	L_{tt}	74.9	27.3	19.8	mH
Moment of rotor inertia	J	1.77 [15.7]	1.77 [15.7]	1.77 [15.7]	kgcm ² [lb-in.sec ² x 10 ⁻⁴]
Weight (without brake)	m	9.0 [19.8]	9.0 [19.8]	9.0 [19.8]	kg [lb]
Recommended cable section (4x)	S	1.5	1.5	1.5	mm ²
Liquid flow rate	Q	1	1	1	l/min
Recommended terminal type	-	Connector Size 1	Connector Size 1	Connector Size 1	-

Optional Holding Brake		Unit
Static braking torque (at 120°C)	9 [79.7]	Nm [lb.in]
Additional weight	0.52 [1.1]	kg [lb]
Additional inertia	0.55 [4.9]	kgcm ² [lb-in.sec ² x 10 ⁻⁴]
Power	15	Watt
Power supply voltage (+6 - 10%)	24	V DC

Notes:

- motor performance levels measured with Moog drives of the appropriate size
- performance in continuous service with $\Delta\theta$ winding = 105°C
- number of motor poles: 6
- DC Link voltage 565V

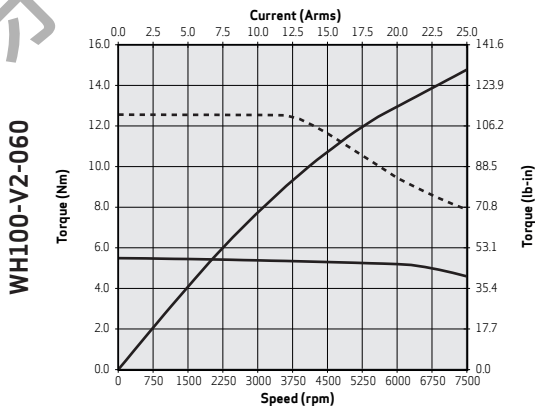
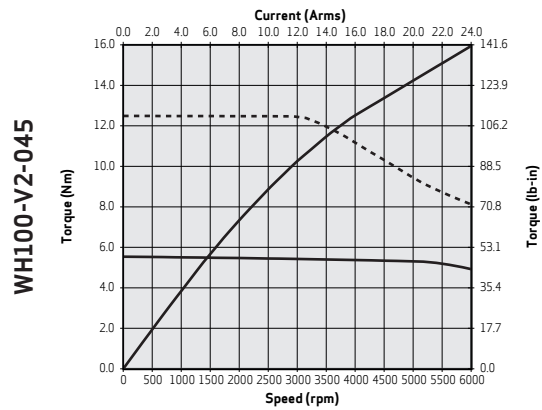
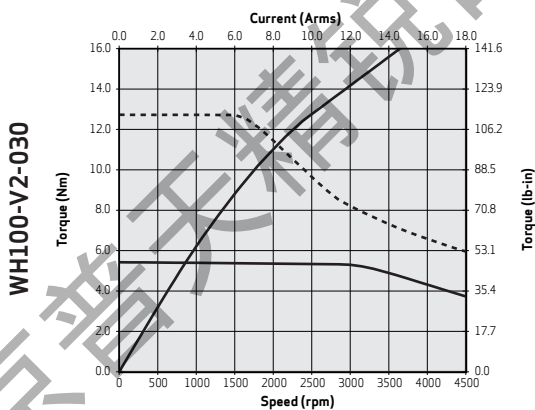

Size WH100 - Liquid cooling					
Characteristics and nominal values with sinusoidal drives					
Size		WH100-V4-030	WH100-V4-045	WH100-V4-060	Units
Nominal torque, continuous service, locked rotor	M_0	11.0 [97.0]	10.8 [95.7]	10.9 [96.8]	Nm [lb.in]
Nominal torque, continuous service, nominal speed	M_N	10.67 [94.4]	10.29 [91.1]	10.13 [89.7]	Nm [lb.in]
Maximum torque	M_{max}	24.5 [216.8]	24.5 [216.8]	24.5 [216.8]	Nm [lb.in]
Nominal speed	n_N	3000	4500	6000	rpm
Maximum speed	n_{max}	4882	6172	8178	rpm
Rated current, locked rotor	I_0	7.60	9.5	12.7	Arms
Peak current	I_p	21	26	35	Arms
Power yield in continuous service at nominal speed	P_N	3.35 [4.49]	4.85 [6.50]	6.36 [8.53]	kW [hp]
Torque constant	k_T	1.44 [12.8]	1.14 [10.1]	0.86 [7.6]	Nm/Arms [lb.in./Arms]
Voltage constant	k_e	94.2	74.5	56.3	Vrms/krpm
Thermal time constant	τ_{Th}	480	480	480	sec
Resistance between the phases at 25°C	R_{tt}	4.69	3.02	1.68	Ohm
Inductance between the phases	L_{tt}	26.3	16.5	9.4	mH
Moment of rotor inertia	J	3.4 [30.1]	3.4 [30.1]	3.4 [30.1]	kgcm ² [lb-in.sec ² x 10 ⁻⁴]
Weight (without brake)	m	11.0 [24.2]	11.0 [24.2]	11.0 [24.2]	kg [lb]
Recommended cable section (4x)	S	1.5	1.5	1.5	mm ²
Liquid flow rate	Q	1.5	1.5	1.5	l/min
Recommended terminal type	-	Connector Size 1	Connector Size 1	Connector Size 1	-

Optional Holding Brake		Unit
Static braking torque (at 120°C)	9 [79.7]	Nm [lb.in]
Additional weight	0.52 [1.1]	kg [lb]
Additional inertia	0.55 [4.9]	kgcm ² [lb-in.sec ² x 10 ⁻⁴]
Power	15	Watt
Power supply voltage (+6 - 10%)	24	V DC

Notes:

- motor performance levels measured with Moog drives of the appropriate size
- performance in continuous service with $\Delta\theta$ winding = 105°C
- number of motor poles: 6
- DC Link voltage 565V

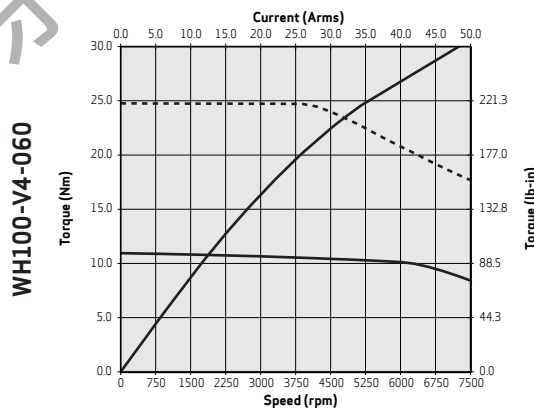
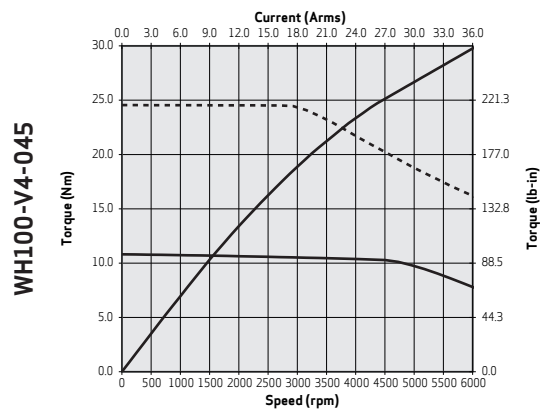
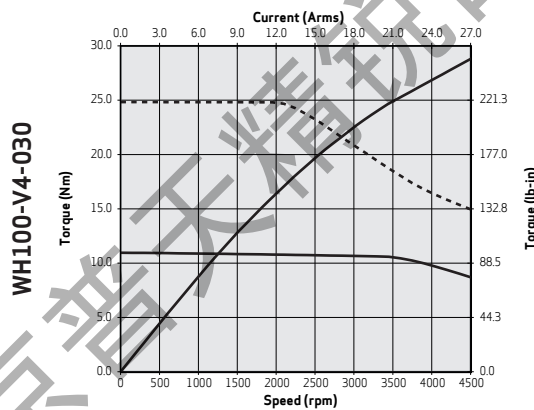

Size WH100 - Liquid cooling					
Characteristics and nominal values with sinusoidal drives					
Size		WH100-V6-020	WH100-V6-030	WH100-V6-045	Units
Nominal torque, continuous service, locked rotor	M_O	16.36 [144.8]	16.29 [144.2]	16.62 [147.1]	Nm [lb.in]
Nominal torque, continuous service, nominal speed	M_N	16.06 [142.2]	15.72 [139.2]	15.68 [138.8]	Nm [lb.in]
Maximum torque	M_{max}	36.5 [323.1]	36.5 [323.1]	36.5 [323.1]	Nm [lb.in]
Nominal speed	n_N	2000	3000	4500	rpm
Maximum speed	n_{max}	2935	4097	6032	rpm
Rated current, locked rotor	I_O	6.82	9.47	14.25	Arms
Peak current	I_p	19	26	39	Arms
Power yield in continuous service at nominal speed	P_N	3.36 [4.51]	4.94 [6.62]	7.39 [9.91]	kW [hp]
Torque constant	k_T	2.40 [21.2]	1.72 [15.2]	1.17 [10.8]	Nm/Arms [lb.in./Arms]
Voltage constant	k_e	156.8	112.3	76.3	Vrms/krpm
Thermal time constant	τ_{Th}	520	520	520	sec
Resistance between the phases at 25°C	R_{tt}	7.56	3.92	1.73	Ohm
Inductance between the phases	L_{tt}	44.8	23.0	10.6	mH
Moment of rotor inertia	J	5.05 [44.7]	5.05 [44.7]	5.05 [44.7]	kgcm ² [lb-in.sec ² x 10 ⁻⁴]
Weight (without brake)	m	13.0 [28.7]	13.0 [28.7]	13.0 [28.7]	kg [lb]
Recommended cable section (4x)	S	1.5	1.5	2.5	mm ²
Liquid flow rate	Q	2	2	2	l/min
Recommended terminal type	-	Connector Size 1	Connector Size 1	Connector Size 1	-

Optional Holding Brake		Unit
Static braking torque (at 120°C)	9 [79.7]	Nm [lb.in]
Additional weight	0.52 [1.1]	kg [lb]
Additional inertia	0.55 [4.9]	kgcm ² [lb-in.sec ² x 10 ⁻⁴]
Power	15	Watt
Power supply voltage (+6 - 10%)	24	V DC

Notes:

- motor performance levels measured with Moog drives of the appropriate size
- performance in continuous service with $\Delta\theta$ winding = 105°C
- number of motor poles: 6
- DC Link voltage 565V

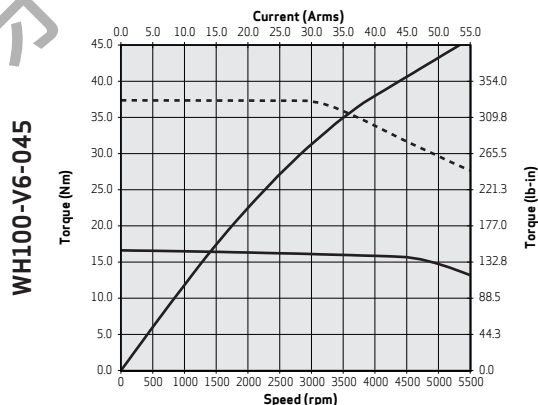
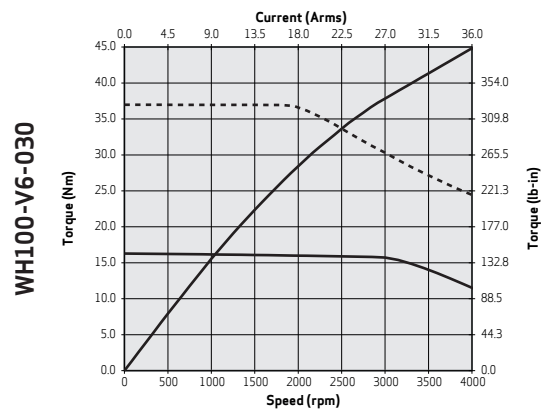
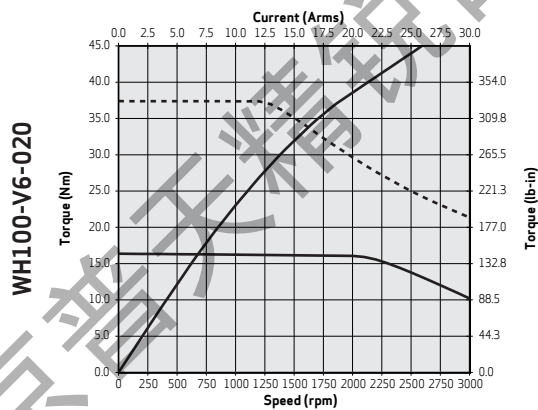

Size WH100 - Liquid cooling					
Characteristics and nominal values with sinusoidal drives					
Size		WH100-V8-020	WH100-V8-030	WH100-V8-045	Units
Nominal torque, continuous service, locked rotor	M_0	21.58[191.0]	22.63[200.3]	22.14[196.0]	Nm [lb.in]
Nominal torque, continuous service, nominal speed	M_N	20.82[184.2]	21.12[187.0]	20.67[183.0]	Nm [lb.in]
Maximum torque	M_{max}	49[433.7]	49[433.7]	49[433.7]	Nm [lb.in]
Nominal speed	n_N	2000	3000	4500	rpm
Maximum speed	n_{max}	2725	3803	5840	rpm
Rated current, locked rotor	I_0	8.35	12.27	18.40	Arms
Peak current	I_p	23	32	49	Arms
Power yield in continuous service at nominal speed	P_N	4.36[5.85]	6.64[8.90]	9.74[13.06]	kW [hp]
Torque constant	k_T	2.59[22.9]	1.84[16.3]	1.20[10.7]	Nm/Arms [lb.in./Arms]
Voltage constant	k_e	168.8	121.0	78.8	Vrms/krpm
Thermal time constant	τ_{Th}	550	550	550	sec
Resistance between the phases at 25°C	R_{tt}	6.17	2.85	1.27	Ohm
Inductance between the phases	L_{tt}	37.0	19.3	8.0	mH
Moment of rotor inertia	J	6.8[60.2]	6.8[60.2]	6.8[60.2]	kgcm ² [lb-in.sec ² x 10 ⁻⁴]
Weight (without brake)	m	15.0[33.1]	15.0[33.1]	15.0[33.1]	kg [lb]
Recommended cable section (4x)	S	1.5	1.5	2.5	mm ²
Liquid flow rate	Q	2.5	2.5	2.5	l/min
Recommended terminal type	-	Connector Size 1	Connector Size 1	Connector Size 1	-

Optional Holding Brake		Unit
Static braking torque (at 120°C)	9[79.7]	Nm [lb.in]
Additional weight	0.52[1.1]	kg [lb]
Additional inertia	0.55 [4.9]	kgcm ² [lb-in.sec ² x 10 ⁻⁴]
Power	15	Watt
Power supply voltage (+6 - 10%)	24	VDC

Notes:

- motor performance levels measured with Moog drives of the appropriate size
- performance in continuous service with $\Delta\theta$ winding = 105°C
- number of motor poles: 6
- DC Link voltage 565V

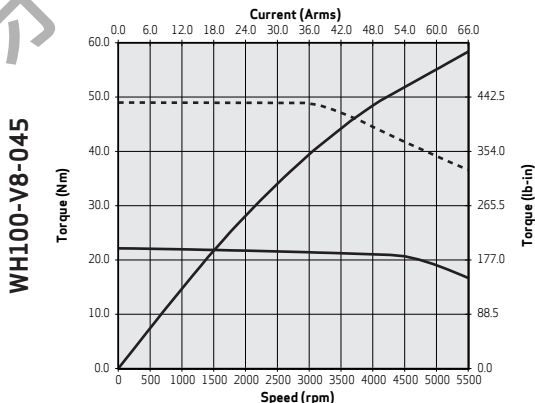
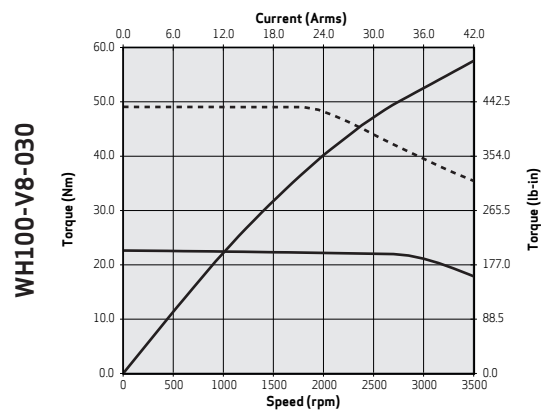
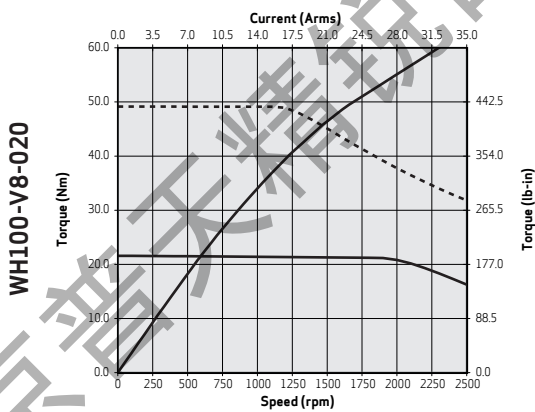

Size WH145 - Liquid cooling					
Characteristics and nominal values with sinusoidal drives					
Size		WH145-V2-020	WH145-V2-030	WH145-V2-045	Units
Nominal torque, continuous service, locked rotor	M_0	18.5 [164.0]	18.5 [164.0]	18.5 [164.0]	Nm [lb.in]
Nominal torque, continuous service, nominal speed	M_N	17.8 [157.5]	17.8 [157.1]	17.2 [152.5]	Nm [lb.in]
Maximum torque	M_{max}	36.7 [324.8]	36.7 [324.8]	36.7 [324.8]	Nm [lb.in]
Nominal speed	n_N	2000	3000	4500	rpm
Maximum speed	n_{max}	2773	4159	6932	rpm
Rated current, locked rotor	I_0	6.98	10.5	17.5	Arms
Peak current	I_p	16	24	40	Arms
Power yield in continuous service at nominal speed	P_N	3.7 [5.00]	5.6 [7.48]	8.1 [10.88]	kW [hp]
Torque constant	k_T	2.65 [23.4]	1.77 [15.7]	1.06 [9.4]	Nm/Arms [lb.in./Arms]
Voltage constant	k_e	165.9	110.6	66.4	Vrms/krpm
Thermal time constant	τ_{Th}	540	540	540	sec
Resistance between the phases at 25°C	R_{tt}	7.03	3.12	1.13	Ohm
Inductance between the phases	L_{tt}	55.6	24.7	8.9	mH
Moment of rotor inertia	J	11.2 [99.1]	11.2 [99.1]	11.2 [99.1]	kgcm ² [lb.in.sec ² x 10 ⁻⁴]
Weight (without brake)	m	14.9 [32.8]	14.9 [32.8]	14.9 [32.8]	kg [lb]
Recommended cable section (4x)	S	1.5	1.5	2.5	mm ²
Liquid flow rate	Q	2	2	2	l/min
Recommended terminal type	-	Connector Size 1	Connector Size 1	Connector Size 1	-

Optional Holding Brake		Unit
Static braking torque (at 120°C)	22 [194.7]	Nm [lb.in]
Additional weight	1.5 [3.3]	kg [lb]
Additional inertia	3 [26.6]	kgcm ² [lb.in.sec ² x 10 ⁻⁴]
Power	19	Watt
Power supply voltage (+6 - 10%)	24	V DC

Notes:

- motor performance levels measured with Moog drives of the appropriate size
- performance in continuous service with $\Delta\theta$ winding = 105°C
- number of motor poles: 6
- DC Link voltage 565V

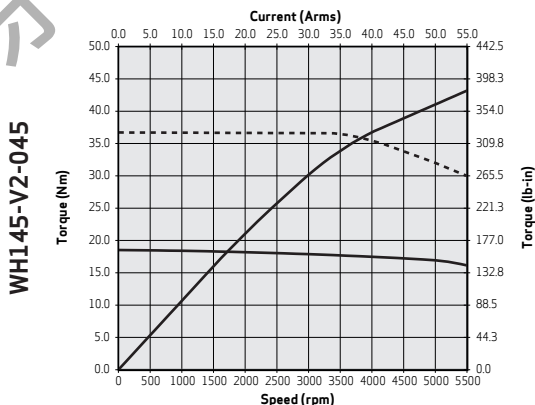
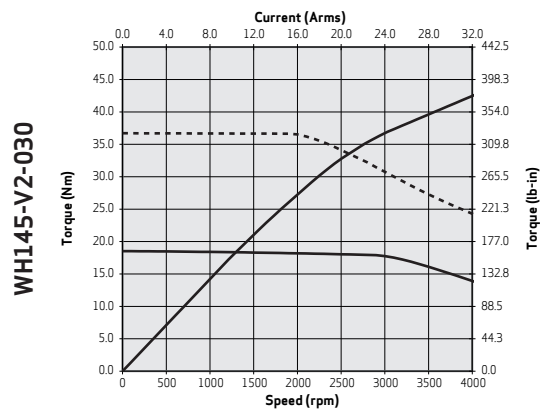
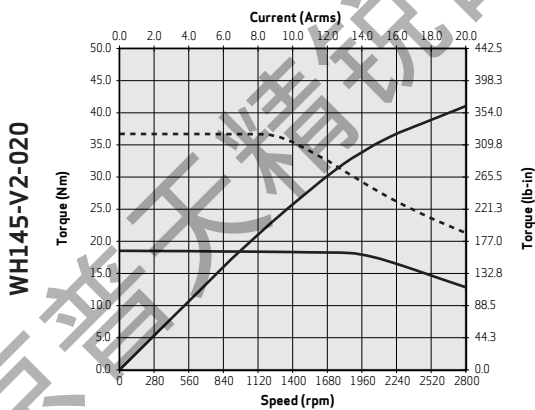

Size WH145 - Liquid cooling					
Characteristics and nominal values with sinusoidal drives					
Size		WH145-V4-020	WH145-V4-030	WH145-V4-040	Units
Nominal torque, continuous service, locked rotor	M_0	37.9[335.7]	37.9[335.7]	37.2[328.9]	Nm [lb.in]
Nominal torque, continuous service, nominal speed	M_N	36.9[326.3]	36.2[320.2]	34.0[300.8]	Nm [lb.in]
Maximum torque	M_{max}	73.4[649.6]	73.4[649.6]	73.4[649.6]	Nm [lb.in]
Nominal speed	n_N	2000	3000	4000	rpm
Maximum speed	n_{max}	2773	4159	5199	rpm
Rated current, locked rotor	I_0	14.3	21.5	26.3	Arms
Peak current	I_p	32	48	60	Arms
Power yield in continuous service at nominal speed	P_N	7.7[10.35]	11.4[15.24]	14.2[19.09]	kW [hp]
Torque constant	k_T	2.65[23.5]	1.77[15.6]	1.42[12.5]	Nm/Arms [lb.in/Arms]
Voltage constant	k_e	165.9	110.6	88.5	Vrms/krpm
Thermal time constant	τ_{Th}	640	640	640	sec
Resistance between the phases at 25°C	R_{tt}	2.44	1.08	0.73	Ohm
Inductance between the phases	L_{tt}	24.3	10.8	6.9	mH
Moment of rotor inertia	J	21.7[192.1]	21.7[192.1]	21.7[192.1]	kgcm ² [lb.in.sec ² x 10 ⁻⁴]
Weight (without brake)	m	20.3[44.8]	20.3[44.8]	20.3[44.8]	kg [lb]
Recommended cable section (4x)	S	2.5	4	4	mm ²
Liquid flow rate	Q	3	3	3	l/min
Recommended terminal type	-	Connector Size 1	Connector Size 1	Connector Size 1	-

Optional Holding Brake		Unit
Static braking torque (at 120°C)	22 [194.7]	Nm [lb.in]
Additional weight	1.5 [3.3]	kg [lb]
Additional inertia	3 [26.6]	kgcm ² [lb.in.sec ² x 10 ⁻⁴]
Power	19	Watt
Power supply voltage (+6 - 10%)	24	V DC

Notes:

- motor performance levels measured with Moog drives of the appropriate size
- performance in continuous service with $\Delta\theta$ winding = 105°C
- number of motor poles: 6
- DC Link voltage 565V

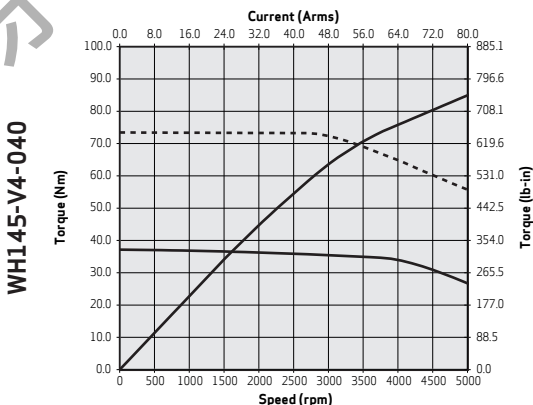
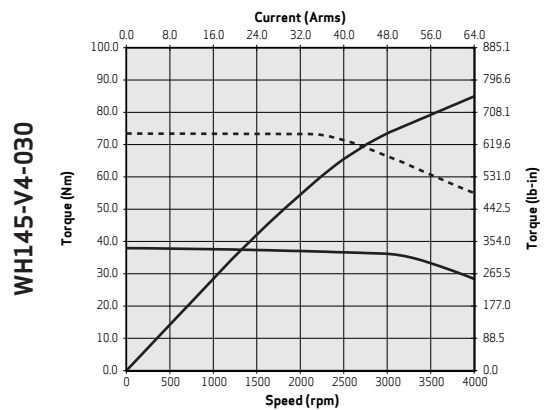
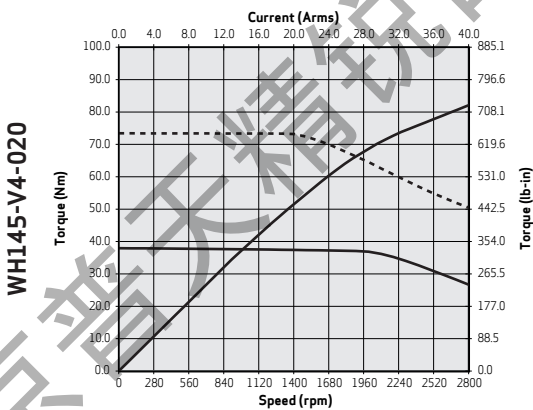

Size WH145 - Liquid cooling					
Characteristics and nominal values with sinusoidal drives					
Size		WH145-V6-020	WH145V6-030	WH145-V6-040	Units
Nominal torque, continuous service, locked rotor	M_O	57.6 [510.1]	58.3 [515.6]	57.6 [510.1]	Nm [lb.in]
Nominal torque, continuous service, nominal speed	M_N	56.0 [495.7]	54.9 [485.6]	52.7 [466.4]	Nm [lb.in]
Maximum torque	M_{max}	110.1 [974.7]	110.1 [974.7]	110.1 [974.7]	Nm [lb.in]
Nominal speed	n_N	2000	3000	4000	rpm
Maximum speed	n_{max}	2773	3961	5546	rpm
Rated current, locked rotor	I_O	21.8	31.5	43.5	Arms
Peak current	I_p	48.0	68.6	96	Arms
Power yield in continuous service at nominal speed	P_N	11.7 [15.73]	17.2 [23.11]	22.1 [29.60]	kW [hp]
Torque constant	k_T	2.65 [23.4]	1.85 [16.4]	1.32 [11.7]	Nm/Arms [lb.in/Arms]
Voltage constant	k_e	165.9	116.1	82.9	Vrms/krpm
Thermal time constant	τ_{Th}	710	710	710	sec
Resistance between the phases at 25°C	R_{tt}	1.39	0.66	0.35	Ohm
Inductance between the phases	L_{tt}	15.5	7.6	3.9	mH
Moment of rotor inertia	J	32.2 [285.0]	32.2 [285.0]	32.2 [285.0]	kgcm ² [lb.in.sec ² x 10 ⁻⁴]
Weight (without brake)	m	25.8 [56.9]	25.8 [56.9]	25.8 [56.9]	kg [lb]
Recommended cable section (4x)	S	4	6	10	mm ²
Liquid flow rate	Q	4	4	4	l/min
Recommended terminal type	-	Connector Size 1.5	Connector Size 1.5	Connector Size 1.5	-

Optional Holding Brake		Unit
Static braking torque (at 120°C)	22 [194.7]	Nm [lb.in]
Additional weight	1.5 [3.3]	kg [lb]
Additional inertia	3 [26.6]	kgcm ² [lb.in.sec ² x 10 ⁻⁴]
Power	19	Watt
Power supply voltage (+6 - 10%)	24	V DC

Notes:

- motor performance levels measured with Moog drives of the appropriate size
- performance in continuous service with $\Delta\theta$ winding = 105°C
- number of motor poles: 6
- DC Link voltage 565V

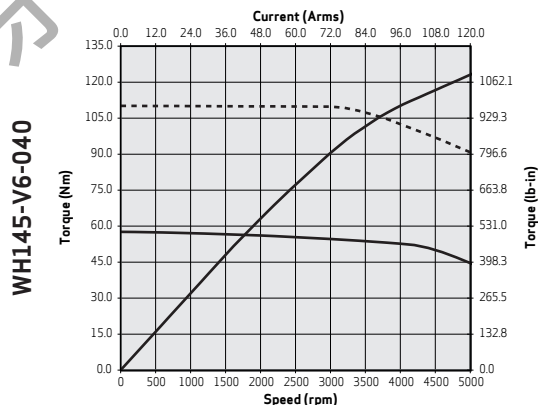
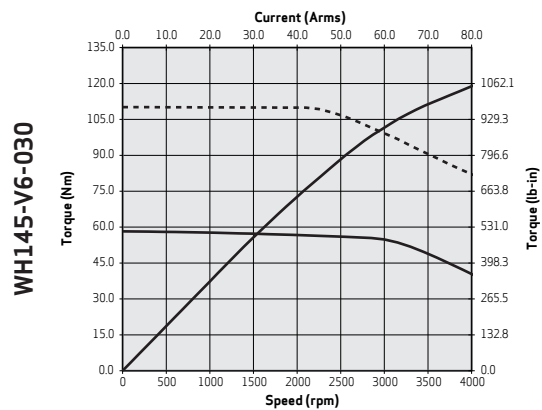
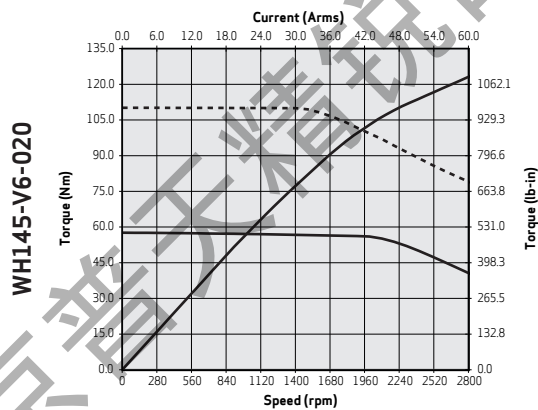

Size WH145 - Liquid cooling					
Characteristics and nominal values with sinusoidal drives					
Size		WH145-V8-020	WH145-V8-030	WH145-V8-040	Units
Nominal torque, continuous service, locked rotor	M_0	77.5 [685.5]	75.6 [669.0]	77.5 [685.5]	Nm [lb.in]
Nominal torque, continuous service, nominal speed	M_N	75.2 [665.6]	71.4 [631.9]	70.0 [619.7]	Nm [lb.in]
Maximum torque	M_{max}	146.8 [1299.3]	146.8 [1299.3]	146.8 [1299.3]	Nm [lb.in]
Nominal speed	n_N	2000	3000	4000	rpm
Maximum speed	n_{max}	2773	4159	5199	rpm
Rated current, locked rotor	I_0	29.3	42.8	54.9	Arms
Peak current	I_p	64	96	120	Arms
Power yield in continuous service at nominal speed	P_N	15.7 [21.12]	22.4 [30.07]	29.3 [39.33]	kW [hp]
Torque constant	k_T	2.65 [23.4]	1.77 [15.6]	1.41 [12.5]	Nm/Arms [lb.in/Arms]
Voltage constant	k_e	165.9	110.6	88.5	Vrms/krpm
Thermal time constant	τ_{Th}	780	780	780	sec
Resistance between the phases at 25°C	R_{tt}	0.95	0.44	0.27	Ohm
Inductance between the phases	L_{tt}	11.3	5.0	3.2	mH
Moment of rotor inertia	J	42.7 [377.9]	42.7 [377.9]	42.7 [377.9]	kgcm ² [lb.in.sec ² x 10 ⁻⁴]
Weight (without brake)	m	31.3 [68.9]	31.3 [68.9]	31.3 [68.9]	kg [lb]
Recommended cable section (4x)	S	6	10	16	mm ²
Liquid flow rate	Q	5	5	5	l/min
Recommended terminal type	-	Connector Size 1.5	Connector Size 1.5	Connector Size 1.5	-

Optional Holding Brake		Unit
Static braking torque (at 120°C)	22 [194.7]	Nm [lb.in]
Additional weight	1.5 [3.3]	kg [lb]
Additional inertia	3 [26.6]	kgcm ² [lb.in.sec ² x 10 ⁻⁴]
Power	19	Watt
Power supply voltage (+6 - 10%)	24	VDC

Notes:

- motor performance levels measured with Moog drives of the appropriate size
- performance in continuous service with $\Delta\theta$ winding = 105°C
- number of motor poles: 6
- DC Link voltage 565V

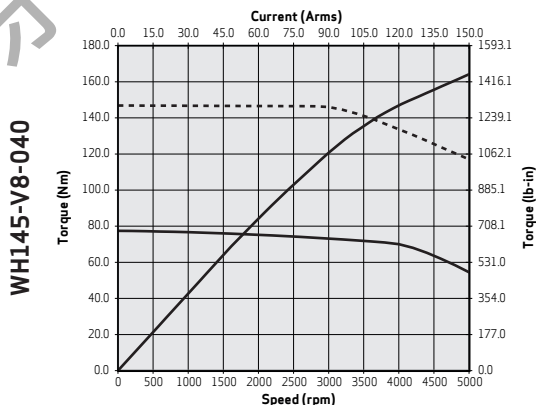
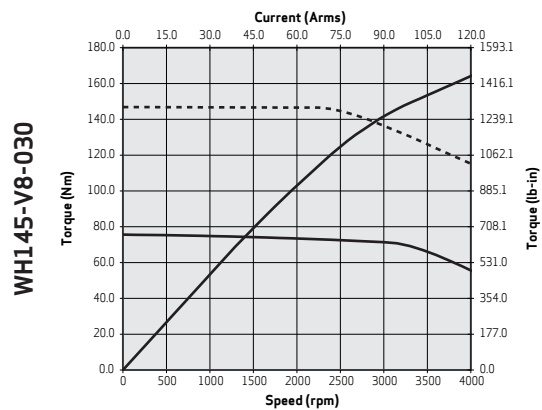
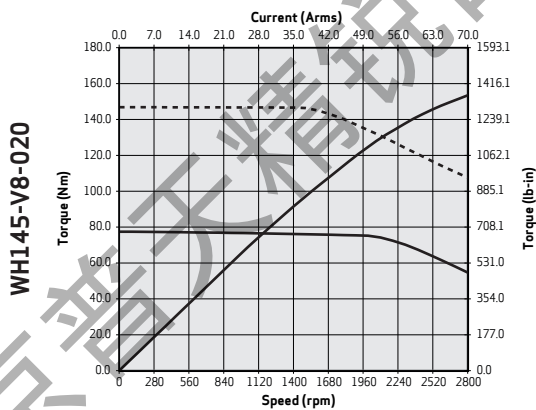

Size WH200 - Liquid cooling					
Characteristics and nominal values with sinusoidal drives					
Size		WH200-V2-020	WH200-V2-030	WH200-V2-045	Units
Nominal torque, continuous service, locked rotor	M_0	48.2 [426.3]	47.1 [416.7]	48.2 [426.3]	Nm [lb.in]
Nominal torque, continuous service, nominal speed	M_N	45.20 [400.1]	41.70 [369.1]	37.12 [328.5]	Nm [lb.in]
Maximum torque	M_{max}	95 [840.8]	95 [840.8]	95 [840.8]	Nm [lb.in]
Nominal speed	n_N	2000	3000	4500	rpm
Maximum speed	n_{max}	3358	5036	6714	rpm
Rated current, locked rotor	I_0	22.3	32.6	44.6	Arms
Peak current	I_p	53	79.4	105.8	Arms
Power yield in continuous service at nominal speed	P_N	9.5 [12.69]	13.1 [17.57]	17.5 [23.45]	kW [hp]
Torque constant	k_T	2.16 [19.1]	1.44 [12.8]	1.08 [9.6]	Nm/Arms [lb.in./Arms]
Voltage constant	k_e	137.0	91.4	68.5	Vrms/krpm
Thermal time constant	τ_{Th}	630	630	630	sec
Resistance between the phases at 25°C	R_{tt}	0.87	0.41	0.22	Ohm
Inductance between the phases	L_{tt}	11.4	5.0	2.8	mH
Moment of rotor inertia	J	93 [821.1]	93 [821.1]	93 [821.1]	kgcm ² [lb-in.sec ² x 10 ⁻⁴]
Weight (without brake)	m	30 [65.5]	30 [65.5]	30 [65.5]	kg [lb]
Recommended cable section (4x)	S	4	6	10	mm ²
Liquid flow rate	Q	3	3	3	l/min
Recommended terminal type	-	Connector Size 1.5	Connector Size 1.5	Connector Size 1.5	-

Optional Holding Brake		Unit
Static braking torque (at 120°C)	22 [194.7]	Nm [lb.in]
Additional weight	1.5 [3.3]	kg [lb]
Additional inertia	3 [26.6]	kgcm ² [lb-in.sec ² x 10 ⁻⁴]
Power	19	Watt
Power supply voltage (+6 - 10%)	24	V DC

Notes:

- motor performance levels measured with Moog drives of the appropriate size
- performance in continuous service with $\Delta\theta$ winding = 105°C
- number of motor poles: 6
- DC Link voltage 565V

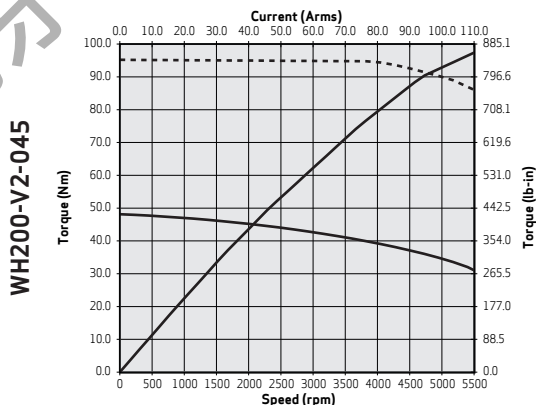
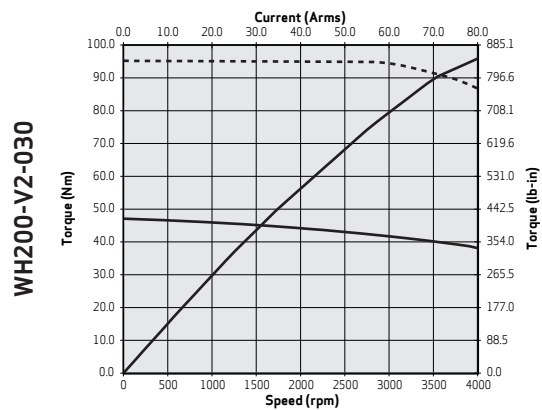
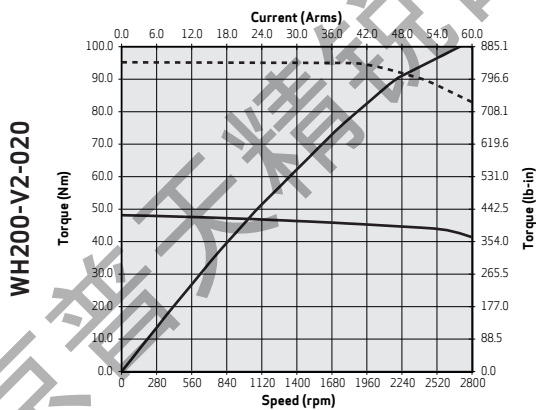

Size WH200 - Liquid cooling					
Characteristics and nominal values with sinusoidal drives					
Size		WH200-P2-014	WH200-P2-022	WH200-P2-035	Units
Nominal torque, continuous service, locked rotor	M_0	68.6[607.2]	69.1[611.4]	69.5[615.2]	Nm [lb.in]
Nominal torque, continuous service, nominal speed	M_N	64.50[570.9]	61.21[541.8]	49.72[440.1]	Nm [lb.in]
Maximum torque	M_{max}	174[1540.0]	174[1540.0]	174[1540.0]	Nm [lb.in]
Nominal speed	n_N	1400	2200	3500	rpm
Maximum speed	n_{max}	2099	2957	4066	rpm
Rated current, locked rotor	I_0	19.0	27.0	37.4	Arms
Peak current	I_p	62	87.3	120	Arms
Power yield in continuous service at nominal speed	P_N	9.5[12.68]	14.1[18.91]	18.2[24.43]	kW [hp]
Torque constant	k_T	3.60[31.9]	2.56[22.6]	1.86[16.5]	Nm/Arms [lb.in/Arms]
Voltage constant	k_e	219.2	155.5	113.1	Vrms/krpm
Thermal time constant	τ_{Th}	630	630	630	sec
Resistance between the phases at 25°C	R_{tt}	1.30	0.64	0.34	Ohm
Inductance between the phases	L_{tt}	9.3	4.7	2.5	mH
Moment of rotor inertia	J	93[821.1]	93[821.1]	93[821.1]	kgcm ² [lb.in.sec ² x 10 ⁻⁴]
Weight (without brake)	m	30[65.5]	30[65.5]	30[65.5]	kg [lb]
Recommended cable section (4x)	S	4	4	10	mm ²
Liquid flow rate	Q	3	3	3	l/min
Recommended terminal type	-	Connector Size 1.5	Connector Size 1.5	Connector Size 1.5	-

Optional Holding Brake		Unit
Static braking torque (at 120°C)	22 [194.7]	Nm [lb.in]
Additional weight	1.5 [3.3]	kg [lb]
Additional inertia	3 [26.6]	kgcm ² [lb.in.sec ² x 10 ⁻⁴]
Power	19	Watt
Power supply voltage (+6 - 10%)	24	V DC

Notes:

- motor performance levels measured with Moog drives of the appropriate size
- performance in continuous service with $\Delta\theta$ winding = 105°C
- number of motor poles: 12
- DC Link voltage 565V

WH200-P2-014

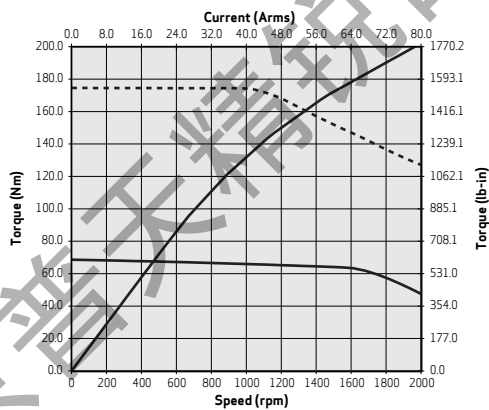

WH200-P2-022

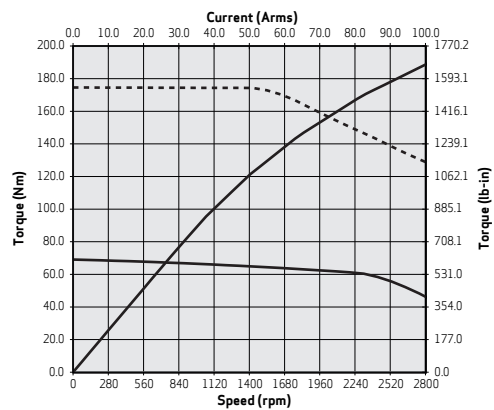

WH200-P2-035

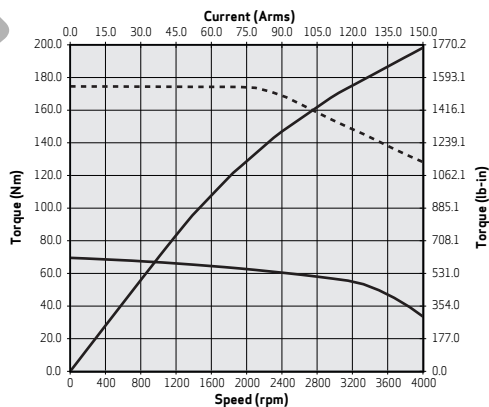

Size WH200 - Liquid cooling					
Characteristics and nominal values with sinusoidal drives					
Size		WH200-V3-020	WH200-V3-030	WH200-V3-039	Units
Nominal torque, continuous service, locked rotor	M_0	73.8[652.9]	75.5[667.9]	73.8[652.9]	Nm [lb.in]
Nominal torque, continuous service, nominal speed	M_N	68.49[606.2]	65.34[578.3]	58.26[515.7]	Nm [lb.in]
Maximum torque	M_{max}	146[1292.2]	146[1292.2]	146[1292.2]	Nm [lb.in]
Nominal speed	n_N	2000	3000	3900	rpm
Maximum speed	n_{max}	3283	4377	5252	rpm
Rated current, locked rotor	I_0	33.4	45.6	53.4	Arms
Peak current	I_p	79	106	127	Arms
Power yield in continuous service at nominal speed	P_N	14.3[19.23]	20.5[27.52]	23.8[31.90]	kW [hp]
Torque constant	k_T	2.21[19.6]	1.71[15.1]	1.38[12.2]	Nm/Arms [lb.in./Arms]
Voltage constant	k_e	140.1	105.1	87.6	Vrms/krpm
Thermal time constant	τ_{Th}	700	700	700	sec
Resistance between the phases at 25°C	R_{tt}	0.51	0.27	0.20	Ohm
Inductance between the phases	L_{tt}	6.9	3.9	2.7	mH
Moment of rotor inertia	J	135[1194.3]	135[1194.3]	135[1194.3]	kgcm ² [lb.in.sec ² x 10 ⁻⁴]
Weight (without brake)	m	38[83.8]	38[83.8]	38[83.8]	kg [lb]
Recommended cable section (4x)	S	6	10	16	mm ²
Liquid flow rate	Q	4	4	4	l/min
Recommended terminal type	-	Connector Size 1.5	Connector Size 1.5	Connector Size 1.5	-

Optional Holding Brake		Unit
Static braking torque (at 120°C)	22 [194.7]	Nm [lb.in]
Additional weight	1.5 [3.3]	kg [lb]
Additional inertia	3 [26.6]	kgcm ² [lb.in.sec ² x 10 ⁻⁴]
Power	19	Watt
Power supply voltage (+6 - 10%)	24	V DC

Notes:

- motor performance levels measured with Moog drives of the appropriate size
- performance in continuous service with $\Delta\theta$ winding = 105°C
- number of motor poles: 6
- DC Link voltage 565V

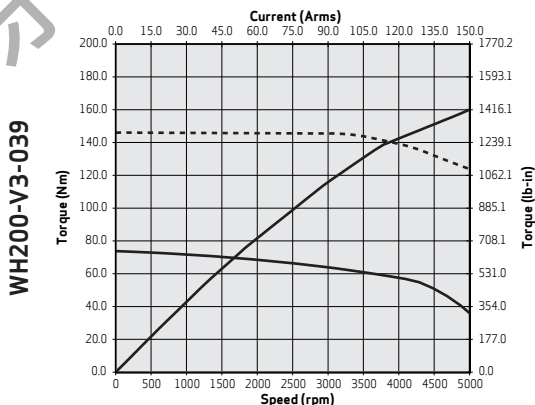
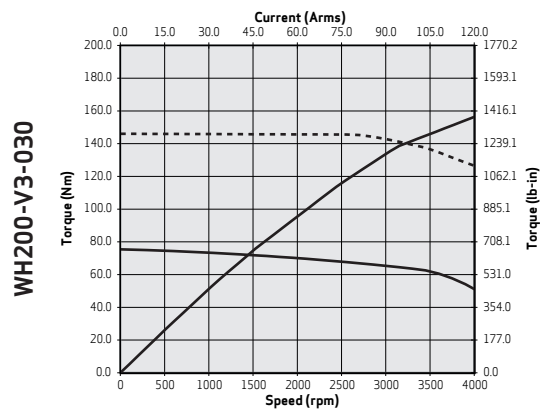
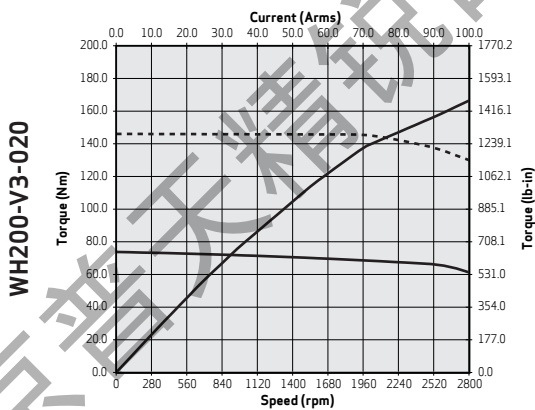

Size WH200 - Liquid cooling					
Characteristics and nominal values with sinusoidal drives					
Size		WH200-P3-018	WH200-P3-022	WH200-P3-035	Units
Nominal torque, continuous service, locked rotor	M_O	107.4 [950.6]	105.3 [931.6]	106.8 [945.5]	Nm [lb.in]
Nominal torque, continuous service, nominal speed	M_N	96.51 [854.2]	91.26 [807.7]	75.28 [666.3]	Nm [lb.in]
Maximum torque	M_{max}	267 [2363.2]	267 [2363.2]	267 [2363.2]	Nm [lb.in]
Nominal speed	n_N	1800	2200	3500	rpm
Maximum speed	n_{max}	2356	2828	4242	rpm
Rated current, locked rotor	I_O	33.4	39.4	59.9	Arms
Peak current	I_p	107	128	192	Arms
Power yield in continuous service at nominal speed	P_N	18.2 [24.39]	21.0 [28.19]	27.6 [36.99]	kW [hp]
Torque constant	k_T	3.21 [28.4]	2.67 [23.7]	1.78 [15.8]	Nm/Arms [lb.in/Arms]
Voltage constant	k_e	195.2	162.7	108.4	Vrms/krpm
Thermal time constant	τ_{Th}	700	700	700	sec
Resistance between the phases at 25°C	R_{tt}	0.56	0.40	0.17	Ohm
Inductance between the phases	L_{tt}	4.7	3.3	1.5	mH
Moment of rotor inertia	J	135 [1194.3]	135 [1194.3]	135 [1194.3]	kgcm ² [lb.in.sec ² x 10 ⁻⁴]
Weight (without brake)	m	38 [83.8]	38 [83.8]	38 [83.8]	kg [lb]
Recommended cable section (4x)	S	6	10	16	mm ²
Liquid flow rate	Q	4	4	4	l/min
Recommended terminal type	-	Connector Size 1.5	Connector Size 1.5	Connector Size 1.5	-

Optional Holding Brake		Unit
Static braking torque (at 120°C)	22 [194.7]	Nm [lb.in]
Additional weight	1.5 [3.3]	kg [lb]
Additional inertia	3 [26.6]	kgcm ² [lb.in.sec ² x 10 ⁻⁴]
Power	19	Watt
Power supply voltage (+6 - 10%)	24	V DC

Notes:

- motor performance levels measured with Moog drives of the appropriate size
- performance in continuous service with $\Delta\theta$ winding = 105°C
- number of motor poles: 12
- DC Link voltage 565V

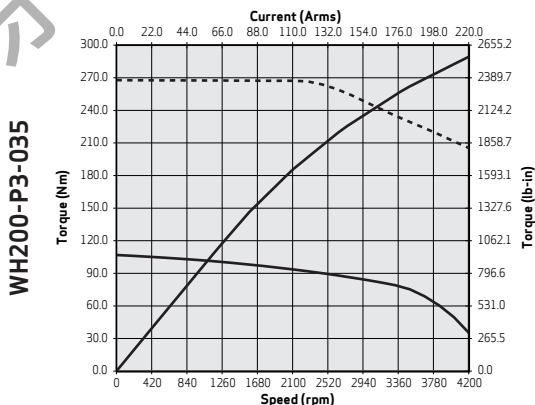
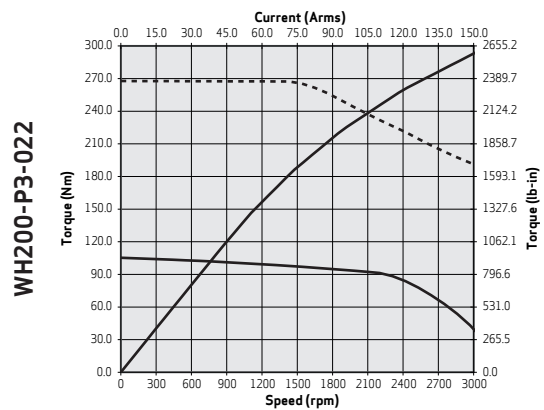
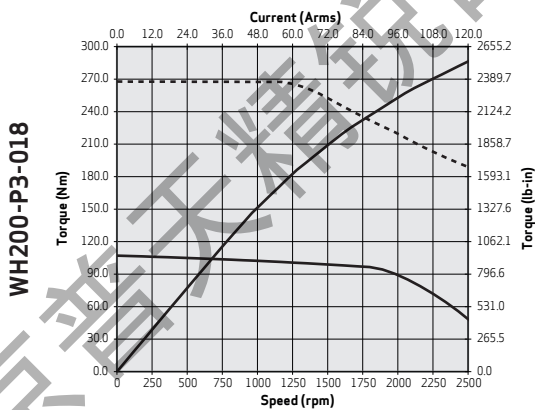

Size WH200 - Liquid cooling					
Characteristics and nominal values with sinusoidal drives					
Size		WH200-V4-014	WH200-V4-020	WH200-V4-030	Units
Nominal torque, continuous service, locked rotor	M_0	103.1 [912.9]	103.4 [915.3]	101.4 [897.6]	Nm [lb.in]
Nominal torque, continuous service, nominal speed	M_N	98.14 [868.7]	95.49 [845.2]	86.51 [765.7]	Nm [lb.in]
Maximum torque	M_{max}	196 [1734.7]	196 [1734.7]	196 [1734.7]	Nm [lb.in]
Nominal speed	n_N	1400	2000	3000	rpm
Maximum speed	n_{max}	1855	2997	4329	rpm
Rated current, locked rotor	I_0	26.4	42.8	60.6	Arms
Peak current	I_p	61	97.7	141.1	Arms
Power yield in continuous service at nominal speed	P_N	14.4 [19.29]	20.0 [26.82]	27.2 [36.44]	kW [hp]
Torque constant	k_T	3.90 [34.5]	2.41 [21.4]	1.67 [14.8]	Nm/Arms [lb.in/Arms]
Voltage constant	k_e	247.9	153.5	106.3	Vrms/krpm
Thermal time constant	τ_{Th}	780	780	780	sec
Resistance between the phases at 25°C	R_{tt}	1.00	0.38	0.19	Ohm
Inductance between the phases	L_{tt}	15.0	5.8	2.8	mH
Moment of rotor inertia	J	177 [1567.5]	177 [1567.5]	177 [1567.5]	kgcm ² [lb.in.sec ² x 10 ⁻⁴]
Weight (without brake)	m	47 [102.5]	47 [102.5]	47 [102.5]	kg [lb]
Recommended cable section (4x)	S	4	10	16	mm ²
Liquid flow rate	Q	5	5	5	l/min
Recommended terminal type	-	Connector Size 1.5	Connector Size 1.5	Connector Size 1.5	-

Optional Holding Brake		Unit
Static braking torque (at 120°C)	80 [708.1]	Nm [lb.in]
Additional weight	5 [11.0]	kg [lb]
Additional inertia	27 [239.0]	kgcm ² [lb.in.sec ² x 10 ⁻⁴]
Power	36.5	Watt
Power supply voltage (+6 - 10%)	24	V DC

Notes:

- motor performance levels measured with Moog drives of the appropriate size
- performance in continuous service with $\Delta\theta$ winding = 105°C
- number of motor poles: 6
- DC Link voltage 565V

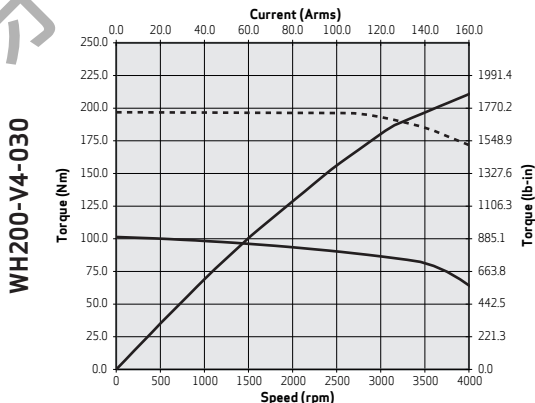
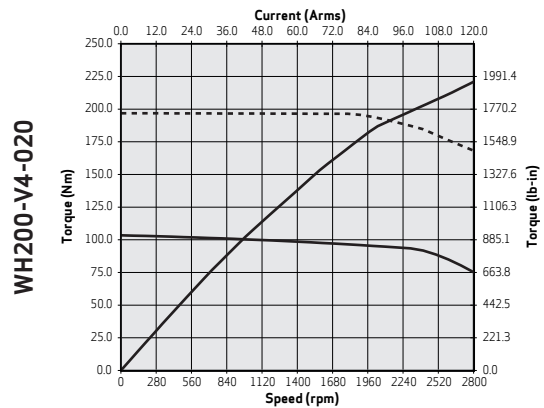
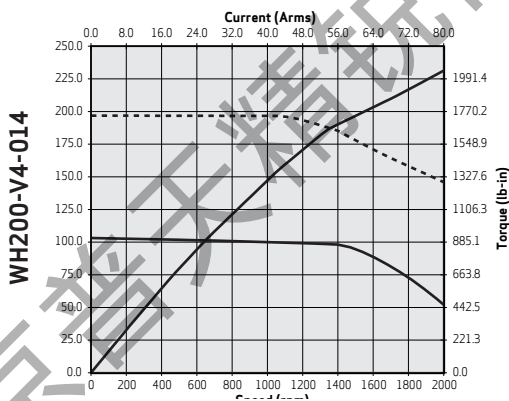

Size WH200 - Liquid cooling					
Characteristics and nominal values with sinusoidal drives					
Size		WH200-P4-014	WH200-P4-018	WH200-P4-027	Units
Nominal torque, continuous service, locked rotor	M_0	146.0 [1292.2]	144.9 [1282.6]	145.8 [1290.2]	Nm [lb.in]
Nominal torque, continuous service, nominal speed	M_N	132.21 [1170.2]	127.72 [1130.5]	110.25 [975.8]	Nm [lb.in]
Maximum torque	M_{max}	360 [3186.3]	360 [3186.3]	360 [3186.3]	Nm [lb.in]
Nominal speed	n_N	1400	1800	2700	rpm
Maximum speed	n_{max}	1748	2247	3146	rpm
Rated current, locked rotor	I_0	33.8	43.1	60.7	Arms
Peak current	I_p	107	137.1	192	Arms
Power yield in continuous service at nominal speed	P_N	19.4 [25.99]	24.1 [32.28]	31.2 [41.80]	kW [hp]
Torque constant	k_T	4.33 [38.3]	3.36 [29.8]	2.40 [21.8]	Nm/Arms [lb.in./Arms]
Voltage constant	k_e	263.2	204.7	146.2	Vrms/krpm
Thermal time constant	τ_{Th}	780	780	780	sec
Resistance between the phases at 25°C	R_{tt}	0.68	0.42	0.21	Ohm
Inductance between the phases	L_{tt}	6.3	3.8	1.9	mH
Moment of rotor inertia	J	177 [1567.5]	177 [1567.5]	177 [1567.5]	kgcm ² [lb.in.sec ² x 10 ⁻⁴]
Weight (without brake)	m	47 [102.5]	47 [102.5]	47 [102.5]	kg [lb]
Recommended cable section (4x)	S	6	10	16	mm ²
Liquid flow rate	Q	5	5	5	l/min
Recommended terminal type	-	Connector Size 1.5	Connector Size 1.5	Connector Size 1.5	-

Optional Holding Brake		Unit
Static braking torque (at 120°C)	80 [708.1]	Nm [lb.in]
Additional weight	5 [11.0]	kg [lb]
Additional inertia	27 [239.0]	kgcm ² [lb.in.sec ² x 10 ⁻⁴]
Power	36.5	Watt
Power supply voltage (+6 - 10%)	24	V DC

Notes:

- motor performance levels measured with Moog drives of the appropriate size
- performance in continuous service with $\Delta\theta$ winding = 105°C
- number of motor poles: 12
- DC Link voltage 565V

WH200-P4-014

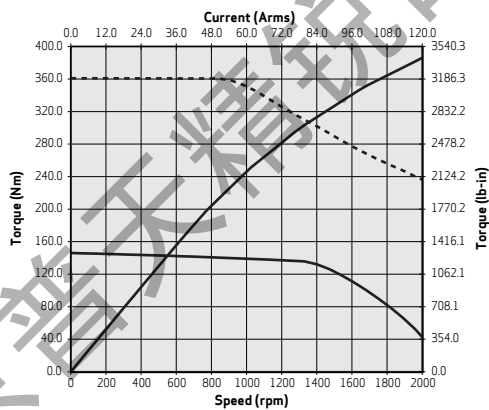

WH200-P4-018

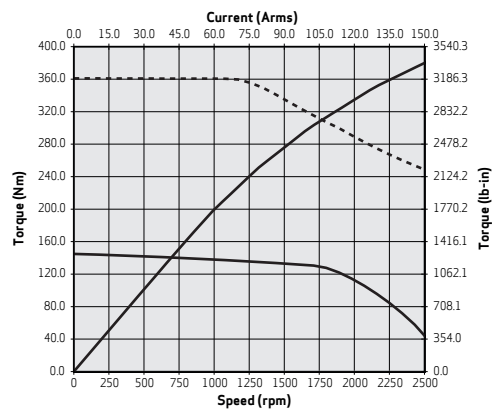

WH200-P4-027

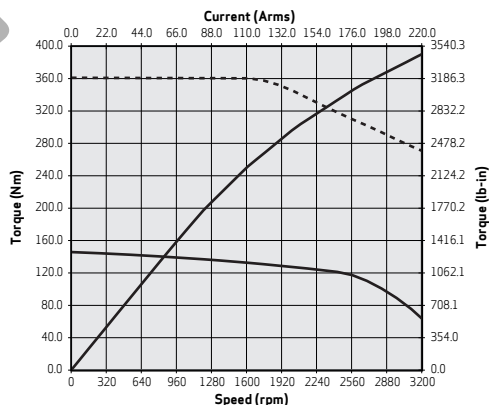

Size WH200 - Liquid cooling					
Characteristics and nominal values with sinusoidal drives					
Size		WH200-V5-020	WH200-V5-025	WH200-V5-033	Units
Nominal torque, continuous service, locked rotor	M_0	131.5 [1164.1]	129.4 [1145.5]	129.1 [1142.2]	Nm [lb.in]
Nominal torque, continuous service, nominal speed	M_N	120.45 [1066.1]	114.40 [1012.6]	105.42 [933.1]	Nm [lb.in]
Maximum torque	M_{max}	248 [2195.0]	248 [2195.0]	248 [2195.0]	Nm [lb.in]
Nominal speed	n_N	2000	2500	3300	rpm
Maximum speed	n_{max}	2569	3425	4404	rpm
Rated current, locked rotor	I_0	46.8	61.2	78.5	Arms
Peak current	I_p	106	141	181	Arms
Power yield in continuous service at nominal speed	P_N	25.2 [33.82]	29.9 [40.16]	36.4 [48.85]	kW [hp]
Torque constant	k_T	2.81 [24.9]	2.11 [18.7]	1.64 [14.6]	Nm/Arms [lb.in/Arms]
Voltage constant	k_e	179.0	134.3	104.4	Vrms/krpm
Thermal time constant	τ_{Th}	800	800	800	sec
Resistance between the phases at 25°C	R_{tt}	0.38	0.22	0.14	Ohm
Inductance between the phases	L_{tt}	6.0	3.4	1.7	mH
Moment of rotor inertia	J	220 [1947.2]	220 [1947.2]	220 [1947.2]	kgcm ² [lb-in.sec ² x 10 ⁻⁴]
Weight (without brake)	m	55 [121.3]	55 [121.3]	55 [121.3]	kg [lb]
Recommended cable section (4x)	S	10	16	25	mm ²
Liquid flow rate	Q	6	6	6	l/min
Recommended terminal type	-	Connector Size 1.5	Connector Size 1.5	Connection box	-

Optional Holding Brake		Unit
Static braking torque (at 120°C)	80 [708.1]	Nm [lb.in]
Additional weight	5 [11.0]	kg [lb]
Additional inertia	27 [239.0]	kgcm ² [lb-in.sec ² x 10 ⁻⁴]
Power	36.5	Watt
Power supply voltage (+6 - 10%)	24	V DC

Notes:

- motor performance levels measured with Moog drives of the appropriate size
- performance in continuous service with $\Delta\theta$ winding = 105°C
- number of motor poles: 6
- DC Link voltage 565V

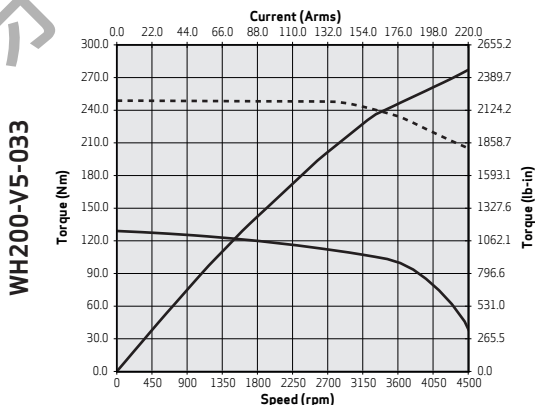
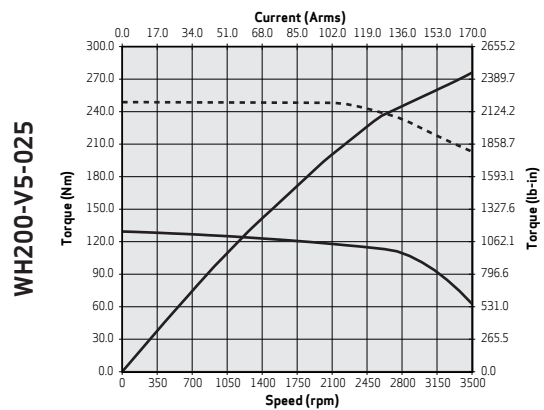
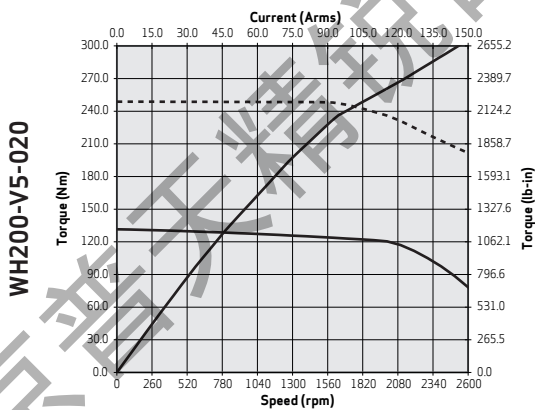

Size WH200 - Liquid cooling					
Characteristics and nominal values with sinusoidal drives					
Size		WH200-P5-014	WH200-P5-018	WH200-P5-026	Units
Nominal torque, continuous service, locked rotor	M_0	183.0 [1619.7]	189.0 [1672.8]	189.0 [1672.8]	Nm [lb.in]
Nominal torque, continuous service, nominal speed	M_N	157.87 [1397.2]	166.30 [1471.8]	147.20 [1302.8]	Nm [lb.in]
Maximum torque	M_{max}	456 [4035.9]	456 [4035.9]	456 [4035.9]	Nm [lb.in]
Nominal speed	n_N	1400	1800	2600	rpm
Maximum speed	n_{max}	1660	2263	3112	rpm
Rated current, locked rotor	I_0	40.2	56.6	77.8	Arms
Peak current	I_p	128	174.6	240	Arms
Power yield in continuous service at nominal speed	P_N	23.1 [31.03]	31.3 [42.03]	40.1 [53.74]	kW [hp]
Torque constant	k_T	4.56 [40.3]	3.34 [29.6]	2.43 [21.5]	Nm/Arms [lb.in/Arms]
Voltage constant	k_e	277.1	203.2	147.8	Vrms/krpm
Thermal time constant	τ_{Th}	800	800	800	sec
Resistance between the phases at 25°C	R_{tt}	0.58	0.29	0.15	Ohm
Inductance between the phases	L_{tt}	5.5	3.0	1.6	mH
Moment of rotor inertia	J	220 [1947.2]	220 [1947.2]	220 [1947.2]	kgcm ² [lb.in.sec ² x 10 ⁻⁴]
Weight (without brake)	m	55 [121.3]	55 [121.3]	55 [121.3]	kg [lb]
Recommended cable section (4x)	S	10	16	25	mm ²
Liquid flow rate	Q	6	6	6	l/min
Recommended terminal type	-	Connector Size 1.5	Connector Size 1.5	Connection box	-

Optional Holding Brake		Unit
Static braking torque (at 120°C)	80 [708.1]	Nm [lb.in]
Additional weight	5 [11.0]	kg [lb]
Additional inertia	27 [239.0]	kgcm ² [lb.in.sec ² x 10 ⁻⁴]
Power	36.5	Watt
Power supply voltage (+6 - 10%)	24	V DC

Notes:

- motor performance levels measured with Moog drives of the appropriate size
- performance in continuous service with $\Delta\theta$ winding = 105°C
- number of motor poles: 12
- DC Link voltage 565V

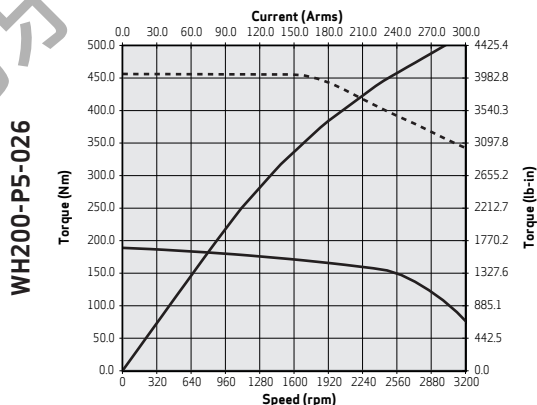
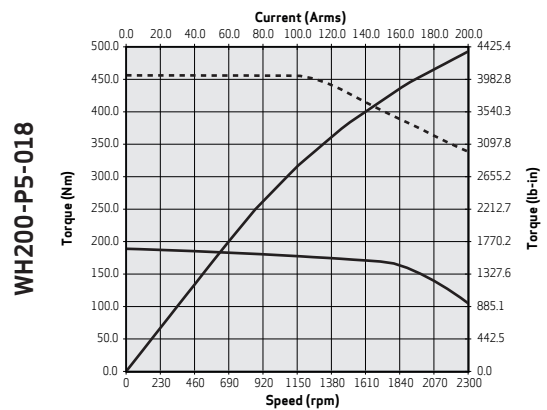
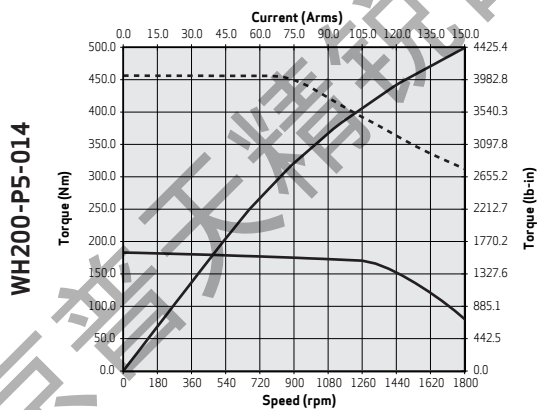

Size WH200 - Liquid cooling					
Characteristics and nominal values with sinusoidal drives					
Size		WH200-V6-012	WH200-V6-020	WH200-V6-025	Units
Nominal torque, continuous service, locked rotor	M_0	156.3 [1382.9]	154.9 [1371.1]	154.9 [1371.1]	Nm [lb.in]
Nominal torque, continuous service, nominal speed	M_N	151.86 [1344.1]	141.50 [1252.4]	136.25 [1205.9]	Nm [lb.in]
Maximum torque	M_{max}	297 [2628.7]	297 [2628.7]	297 [2628.7]	Nm [lb.in]
Nominal speed	n_N	1200	2000	2500	rpm
Maximum speed	n_{max}	1842	2578	3223	rpm
Rated current, locked rotor	I_0	40.4	55.2	69.0	Arms
Peak current	I_p	91	127	159	Arms
Power yield in continuous service at nominal speed	P_N	19.1 [25.59]	29.6 [39.74]	35.7 [47.83]	kW [hp]
Torque constant	k_T	3.92 [34.7]	2.81 [24.9]	2.25 [19.9]	Nm/Arms [lb.in./Arms]
Voltage constant	k_e	249.8	178.4	142.7	Vrms/krpm
Thermal time constant	τ_{Th}	880	880	880	sec
Resistance between the phases at 25°C	R_{tt}	0.59	0.32	0.20	Ohm
Inductance between the phases	L_{tt}	9.5	4.8	3.1	mH
Moment of rotor inertia	J	261 [2306.4]	261 [2306.4]	261 [2306.4]	kgcm ² [lb-in.sec ² x 10 ⁻⁴]
Weight (without brake)	m	63 [139.2]	63 [139.2]	63 [139.2]	kg [lb]
Recommended cable section (4x)	S	10	16	16	mm ²
Liquid flow rate	Q	6	6	6	l/min
Recommended terminal type	-	Connector Size 1.5	Connector Size 1.5	Connector Size 1.5	-

Optional Holding Brake		Unit
Static braking torque (at 120°C)	80 [708.1]	Nm [lb.in]
Additional weight	5 [11.0]	kg [lb]
Additional inertia	27 [239.0]	kgcm ² [lb-in.sec ² x 10 ⁻⁴]
Power	36.5	Watt
Power supply voltage (+6 - 10%)	24	V DC

Notes:

- motor performance levels measured with Moog drives of the appropriate size
- performance in continuous service with $\Delta\theta$ winding = 105°C
- number of motor poles: 6
- DC Link voltage 565V

WH200-V6-012

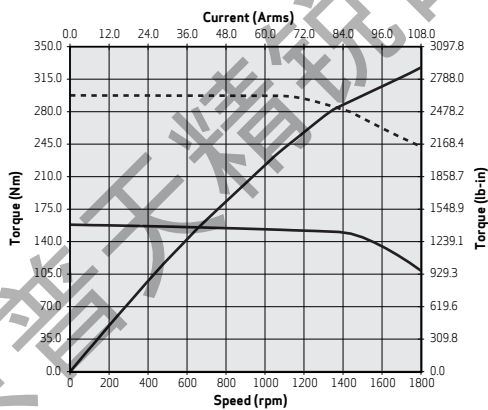

WH200-V6-020

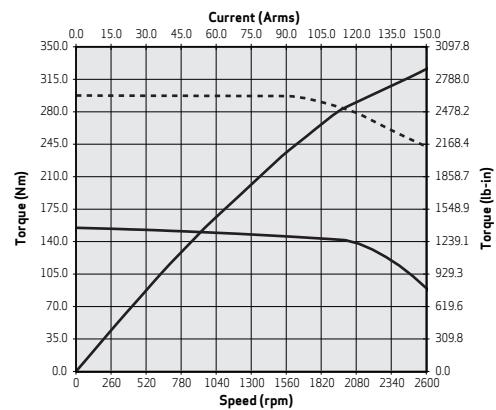

WH200-V6-025

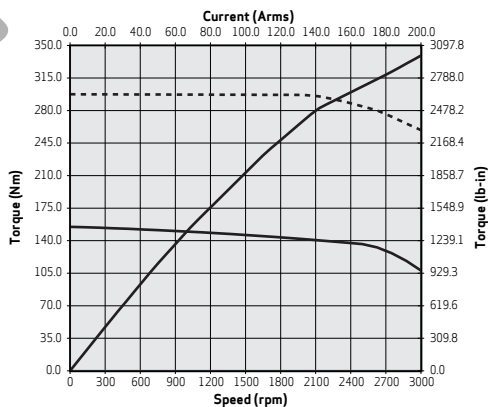

Size WH200 - Liquid cooling					
Characteristics and nominal values with sinusoidal drives					
Size		WH200-P6-011	WH200-P6-015	WH200-P6-022	Units
Nominal torque, continuous service, locked rotor	M_0	220.1 [1948.4]	227.3 [2012.0]	227.3 [2012.0]	Nm [lb.in]
Nominal torque, continuous service, nominal speed	M_N	202.87 [1795.5]	204.43 [1809.4]	183.23 [1621.8]	Nm [lb.in]
Maximum torque	M_{max}	545 [4823.7]	545 [4823.7]	545 [4823.7]	Nm [lb.in]
Nominal speed	n_N	1100	1500	2200	rpm
Maximum speed	n_{max}	1388	1893	2603	rpm
Rated current, locked rotor	I_0	40.4	56.9	78.3	Arms
Peak current	I_p	128	175	240	Arms
Power yield in continuous service at nominal speed	P_N	23.4 [31.33]	32.1 [43.05]	42.2 [56.60]	kW [hp]
Torque constant	k_T	5.45 [48.2]	3.99 [35.4]	2.91 [25.7]	Nm/Arms [lb.in./Arms]
Voltage constant	k_e	331.4	243.0	176.7	Vrms/krpm
Thermal time constant	τ_{Th}	880	880	880	sec
Resistance between the phases at 25°C	R_{tt}	0.66	0.33	0.18	Ohm
Inductance between the phases	L_{tt}	6.6	3.5	1.9	mH
Moment of rotor inertia	J	261 [2306.4]	261 [2306.4]	261 [2306.4]	kgcm ² [lb.in.sec ² x 10 ⁻⁴]
Weight (without brake)	m	63 [139.2]	63 [139.2]	63 [139.2]	kg [lb]
Recommended cable section (4x)	S	10	16	25	mm ²
Liquid flow rate	Q	6	6	6	l/min
Recommended terminal type	-	Connector Size 1.5	Connector Size 1.5	Connection box	-

Optional Holding Brake		Unit
Static braking torque (at 120°C)	80 [708.1]	Nm [lb.in]
Additional weight	5 [11.0]	kg [lb]
Additional inertia	27 [239.0]	kgcm ² [lb.in.sec ² x 10 ⁻⁴]
Power	36.5	Watt
Power supply voltage (+6 - 10%)	24	V DC

Notes:

- motor performance levels measured with Moog drives of the appropriate size
- performance in continuous service with $\Delta\theta$ winding = 105°C
- number of motor poles: 12
- DC Link voltage 565V

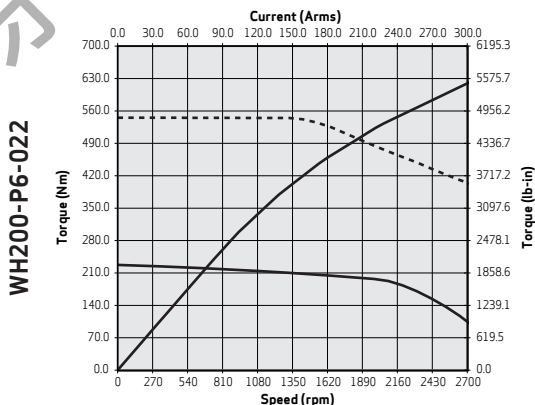
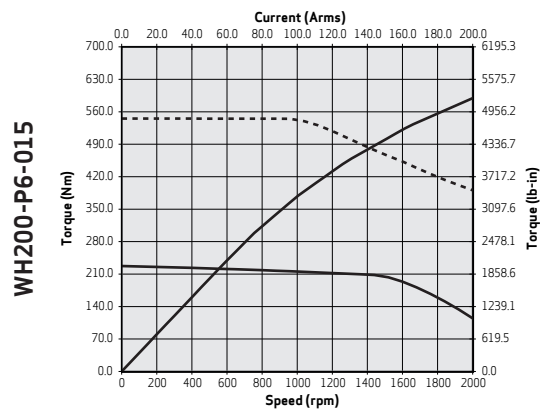
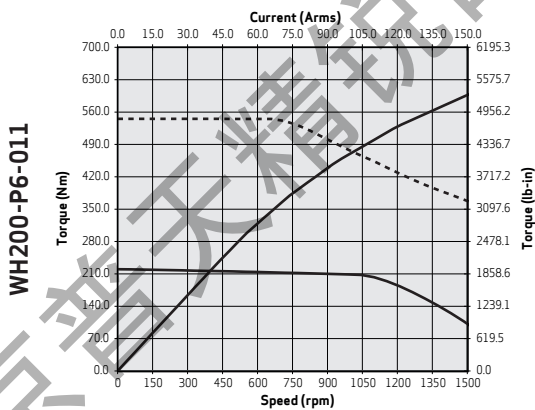

Size WH200 - Liquid cooling					
Characteristics and nominal values with sinusoidal drives					
Size		WH200-V8-012	WH200-V8-016	WH200-V8-020	Units
Nominal torque, continuous service, locked rotor	M_0	212.0 [1876.2]	210.4 [1861.9]	213.6 [1890.5]	Nm [lb.in]
Nominal torque, continuous service, nominal speed	M_N	203.02 [1796.9]	196.84 [1742.1]	194.87 [1724.7]	Nm [lb.in]
Maximum torque	M_{max}	398 [3522.6]	398 [3522.6]	398 [3522.6]	Nm [lb.in]
Nominal speed	n_N	1200	1600	2000	rpm
Maximum speed	n_{max}	1752	2141	2753	rpm
Rated current, locked rotor	I_0	51.5	62.3	81.6	Arms
Peak current	I_p	116	141	181	Arms
Power yield in continuous service at nominal speed	P_N	25.5 [34.21]	33.0 [44.22]	40.8 [54.72]	kW [hp]
Torque constant	k_T	4.12 [36.5]	3.38 [29.9]	2.62 [23.2]	Nm/Arms [lb.in./Arms]
Voltage constant	k_e	262.6	214.9	167.1	Vrms/krpm
Thermal time constant	τ_{Th}	1050	1050	1050	sec
Resistance between the phases at 25°C	R_{tt}	0.46	0.32	0.18	Ohm
Inductance between the phases	L_{tt}	7.6	5.1	3.1	mH
Moment of rotor inertia	J	344 [3044.7]	344 [3044.7]	344 [3044.7]	kgcm ² [lb.in.sec ² x 10 ⁻⁴]
Weight (without brake)	m	80 [175.8]	80 [175.8]	80 [175.8]	kg [lb]
Recommended cable section (4x)	S	10	16	25	mm ²
Liquid flow rate	Q	8	8	8	l/min
Recommended terminal type	-	Connector Size 1.5	Connector Size 1.5	Connection box	-

Optional Holding Brake		Unit
Static braking torque (at 120°C)	80 [708.1]	Nm [lb.in]
Additional weight	5 [11.0]	kg [lb]
Additional inertia	27 [239.0]	kgcm ² [lb.in.sec ² x 10 ⁻⁴]
Power	36.5	Watt
Power supply voltage (+6 - 10%)	24	VDC

Notes:

- motor performance levels measured with Moog drives of the appropriate size
- performance in continuous service with $\Delta\theta$ winding = 105°C
- number of motor poles: 6
- DC Link voltage 565V

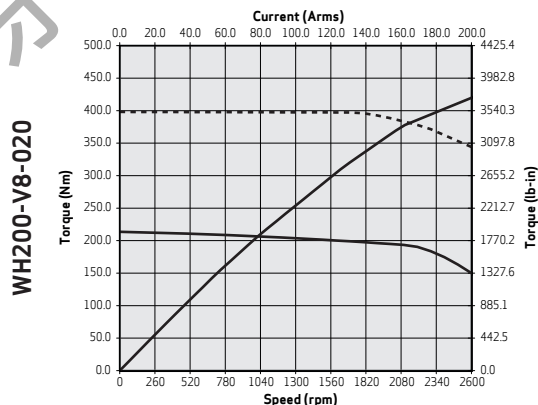
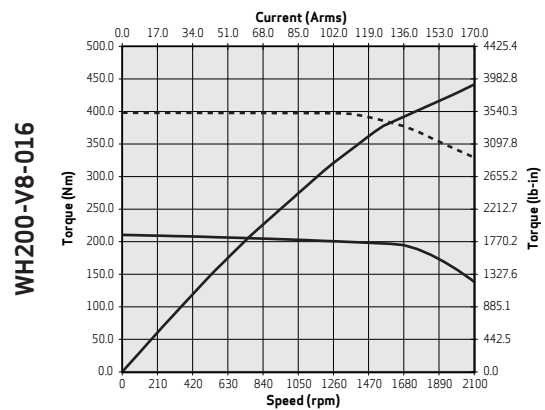
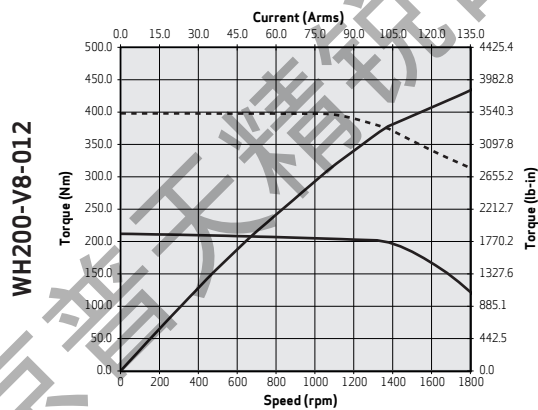

Size WH200 - Liquid cooling					
Characteristics and nominal values with sinusoidal drives					
Size		WH200-P8-010	WH200-P8-014	WH200-P8-018	Units
Nominal torque, continuous service, locked rotor	M_0	299.6 [2652.0]	302.3 [2675.5]	305.8 [2706.4]	Nm [lb.in]
Nominal torque, continuous service, nominal speed	M_N	281.13 [2488.2]	269.96 [2389.4]	263.84 [2335.2]	Nm [lb.in]
Maximum torque	M_{max}	725 [6416.8]	725 [6416.8]	725 [6416.8]	Nm [lb.in]
Nominal speed	n_N	1000	1400	1800	rpm
Maximum speed	n_{max}	1297	1729	2223	rpm
Rated current, locked rotor	I_0	51.4	69.1	89.9	Arms
Peak current	I_p	160	213	274	Arms
Power yield in continuous service at nominal speed	P_N	29.4 [39.47]	39.6 [53.07]	49.7 [66.68]	kW [hp]
Torque constant	k_T	5.83 [51.6]	4.37 [38.7]	3.40 [30.1]	Nm/Arms [lb.in/Arms]
Voltage constant	k_e	354.7	266.1	206.9	Vrms/krpm
Thermal time constant	τ_{Th}	1050	1050	1050	sec
Resistance between the phases at 25°C	R_{tt}	0.52	0.29	0.17	Ohm
Inductance between the phases	L_{tt}	5.6	3.1	1.9	mH
Moment of rotor inertia	J	344 [3044.7]	344 [3044.7]	344 [3044.7]	kgcm ² [lb.in.sec ² x 10 ⁻⁴]
Weight (without brake)	m	80 [175.8]	80 [175.8]	80 [175.8]	kg [lb]
Recommended cable section (4x)	S	10	16	25	mm ²
Liquid flow rate	Q	8	8	8	l/min
Recommended terminal type	-	Connector Size 1.5	Connector Size 1.5	Connection box	-

Optional Holding Brake		Unit
Static braking torque (at 120°C)	80 [708.1]	Nm [lb.in]
Additional weight	5 [11.0]	kg [lb]
Additional inertia	27 [239.0]	kgcm ² [lb.in.sec ² x 10 ⁻⁴]
Power	36.5	Watt
Power supply voltage (+6 - 10%)	24	VDC

Notes:

- motor performance levels measured with Moog drives of the appropriate size
- performance in continuous service with $\Delta\theta$ winding = 105°C
- number of motor poles: 12
- DC Link voltage 565V
- handbrake available upon request

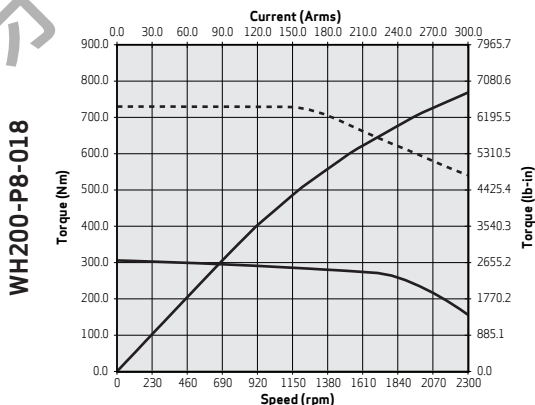
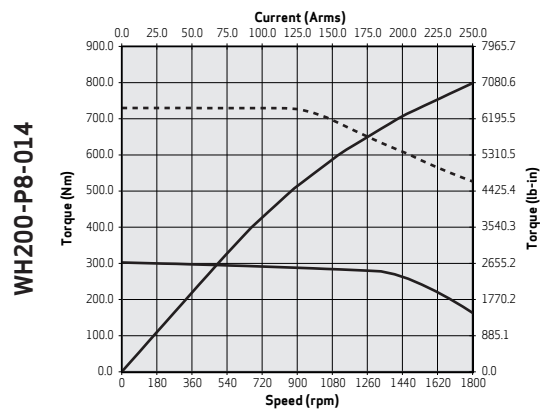
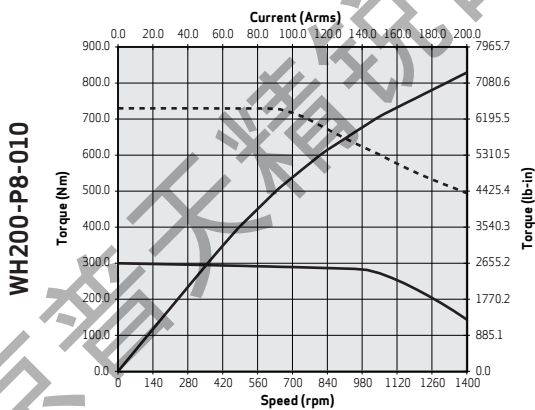

Size WH275 - Liquid cooling				
Characteristics and nominal values with sinusoidal drives				
Size		WH275-V3-012	WH275-V3-020	Units
Nominal torque, continuous service, locked rotor	M_O	339.0 [3000.4]	341.0 [3018.1]	Nm [lb.in]
Nominal torque, continuous service, nominal speed	M_N	314.4 [2782.8]	283.3 [2507.0]	Nm [lb.in]
Maximum torque	M_{max}	457 [4044.8]	457 [4044.8]	Nm [lb.in]
Nominal speed	n_N	1200	2000	rpm
Maximum speed	n_{max}	1658	2818	rpm
Rated current, locked rotor	I_O	75.8	129.8	Arms
Peak current	I_p	111	189	Arms
Power yield in continuous service at nominal speed	P_N	39.5 [52.97]	59.3 [79.54]	kW [hp]
Torque constant	k_T	4.48 [39.6]	2.63 [23.3]	Nm/Arms [lb-in/Arms]
Voltage constant	k_e	277.5	163.2	Vrms/krpm
Thermal time constant	τ_{Th}	1500	1500	sec
Resistance between the phases at 25°C	R_{tt}	0.16	0.05	Ohm
Inductance between the phases	L_{tt}	4.9	1.7	mH
Moment of rotor inertia	J	687 [6080.5]	687 [6080.5]	kgcm ² [lb.in.sec ² x 10 ⁻⁴]
Weight (without brake)	m	119 [262.3]	119 [262.3]	kg [lb]
Recommended cable section (4x)	S	25	35	mm ²
Liquid flow rate	Q	6	6	l/min
Recommended terminal type	-	Connection box	Connection box	-

Notes:

- motor performance levels measured with Moog drives of the appropriate size
- performance in continuous service with $\Delta\theta$ winding = 105°C
- number of motor poles: 8
- DC Link voltage 565V
- handbrake available upon request
- personalised windings available upon request

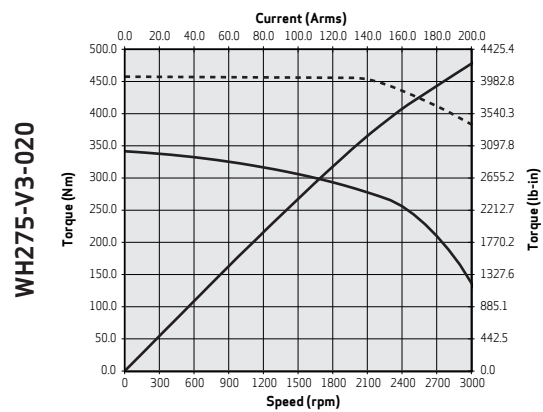
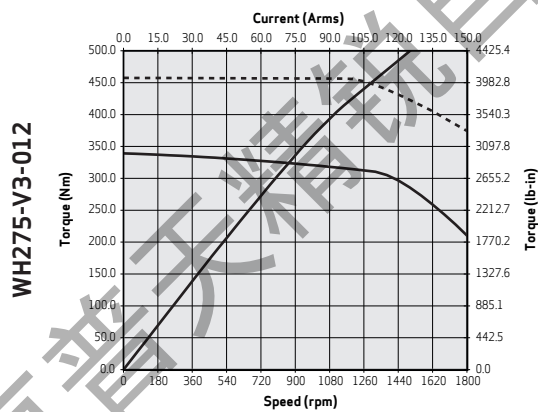

Size WH275 - Liquid cooling					
Characteristics and nominal values with sinusoidal drives					
Size		WH275-P3-008	WH275-P3-011	WH275-P4-011	Units
Nominal torque, continuous service, locked rotor	M_0	367.0 [3248.2]	361.0 [3195.1]	489.6 [4333.3]	Nm [lb.in]
Nominal torque, continuous service, nominal speed	M_N	334.3 [2958.7]	307.4 [2720.5]	408.9 [3618.8]	Nm [lb.in]
Maximum torque	M_{max}	721 [6381.4]	721 [6381.4]	974 [8620.6]	Nm [lb.in]
Nominal speed	n_N	800	1100	1100	rpm
Maximum speed	n_{max}	1109	1479	1461	rpm
Rated current, locked rotor	I_0	55.0	72.0	96.5	Arms
Peak current	I_p	138	183	244	Arms
Power yield in continuous service at nominal speed	P_N	28.0 [37.55]	35.4 [47.47]	47.1 [63.15]	kW [hp]
Torque constant	k_T	6.67 [59.0]	5.01 [44.4]	5.07 [44.9]	Nm/Arms [lb.in/Arms]
Voltage constant	k_e	414.8	311.1	314.9	Vrms/krpm
Thermal time constant	τ_{Th}	1500	1500	1700	sec
Resistance between the phases at 25°C	R_{tt}	0.30	0.18	0.12	Ohm
Inductance between the phases	L_{tt}	6.9	3.9	2.9	mH
Moment of rotor inertia	J	687 [6080.5]	687 [6080.5]	919 [8133.8]	kgcm ² [lb.in.sec ² x 10 ⁻⁴]
Weight (without brake)	m	119 [262.3]	119 [262.3]	147 [324.1]	kg [lb]
Recommended cable section (4x)	S	16	25	35	mm ²
Liquid flow rate	Q	6	6	7	l/min
Recommended terminal type	-	Connector Size 1.5	Connection box	Connection box	-

Notes:

- motor performance levels measured with Moog drives of the appropriate size
- performance in continuous service with $\Delta\theta$ winding = 105°C
- number of motor poles: 16
- DC Link voltage 565V
- handbrake available upon request
- personalised windings available upon request

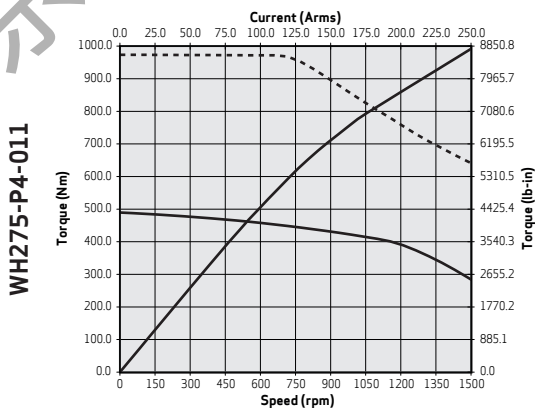
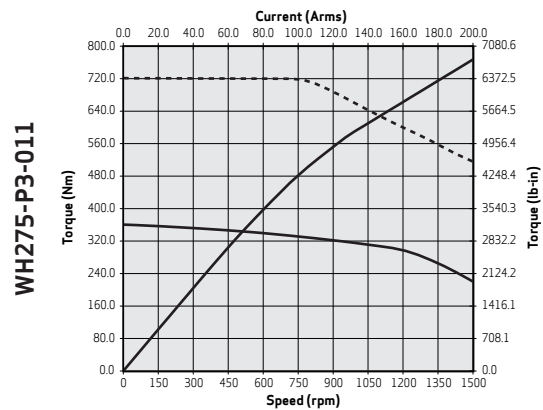
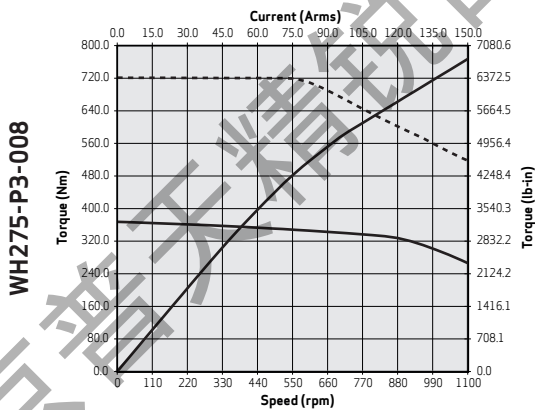

Size WH275 - Liquid cooling				
Characteristics and nominal values with sinusoidal drives				
Size		WH275-V4-010	WH275-V4-015	Units
Nominal torque, continuous service, locked rotor	M_O	461.0 [4080.2]	461.0 [4080.2]	Nm [lb.in]
Nominal torque, continuous service, nominal speed	M_N	432.7 [3830.0]	398.0 [3522.3]	Nm [lb.in]
Maximum torque	M_{max}	617 [5460.9]	617 [5460.9]	Nm [lb.in]
Nominal speed	n_N	1000	1500	rpm
Maximum speed	n_{max}	1392	1740	rpm
Rated current, locked rotor	I_O	86.5	108.1	Arms
Peak current	I_p	126	157.5	Arms
Power yield in continuous service at nominal speed	P_N	45.3 [60.76]	62.5 [83.81]	kW [hp]
Torque constant	k_T	5.33 [47.2]	4.26 [37.7]	Nm/Arms [lb-in/Arms]
Voltage constant	k_e	330.5	264.4	Vrms/krpm
Thermal time constant	τ_{Th}	1700	1700	sec
Resistance between the phases at 25°C	R_{tt}	0.15	0.09	Ohm
Inductance between the phases	L_{tt}	5.1	3.3	mH
Moment of rotor inertia	J	919 [8133.8]	919 [8133.8]	kgcm ² [lb-in.sec ² x 10 ⁻⁴]
Weight (without brake)	m	147 [324.1]	147 [324.1]	kg [lb]
Recommended cable section (4x)	S	25	35	mm ²
Liquid flow rate	Q	7	7	l/min
Recommended terminal type	-	Connection box	Connection box	-

Notes:

- motor performance levels measured with Moog drives of the appropriate size
- performance in continuous service with $\Delta\theta$ winding = 105°C
- number of motor poles: 8
- DC Link voltage 565V
- handbrake available upon request
- personalised windings available upon request

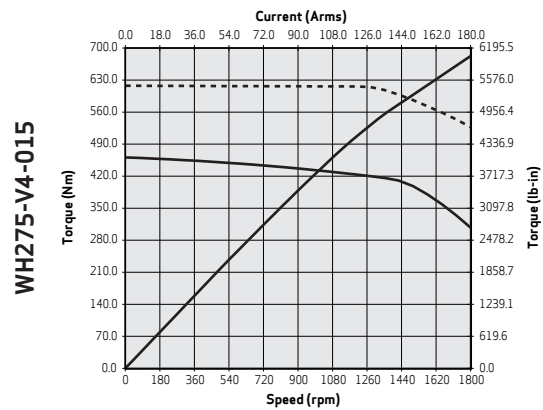
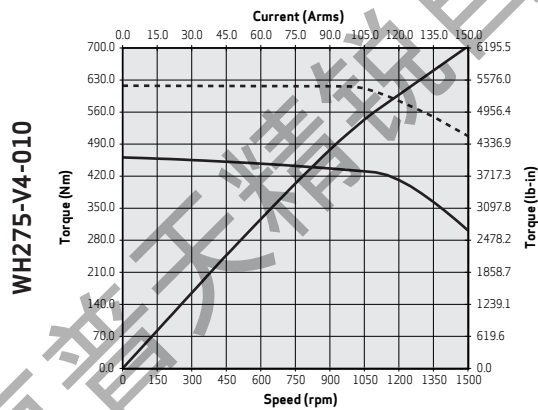

Size WH275 - Liquid cooling				
Characteristics and nominal values with sinusoidal drives				
Size		WH275-V5-010	WH275-V5-015	Units
Nominal torque, continuous service, locked rotor	M_O	582.0 [5151.1]	583.0 [5160.0]	Nm [lb.in]
Nominal torque, continuous service, nominal speed	M_N	544.2 [4816.6]	479.9 [4247.6]	Nm [lb.in]
Maximum torque	M_{max}	781 [6912.4]	781 [6912.4]	Nm [lb.in]
Nominal speed	n_N	1000	1500	rpm
Maximum speed	n_{max}	1269	1650	rpm
Rated current, locked rotor	I_O	99.7	129.8	Arms
Peak current	I_p	145	189	Arms
Power yield in continuous service at nominal speed	P_N	57.0 [76.41]	75.4 [101.07]	kW [hp]
Torque constant	k_T	5.84 [51.7]	4.49 [39.7]	Nm/Arms [lb-in/Arms]
Voltage constant	k_e	362.4	278.8	Vrms/krpm
Thermal time constant	τ_{Th}	1950	1950	sec
Resistance between the phases at 25°C	R_{tt}	0.13	0.08	Ohm
Inductance between the phases	L_{tt}	4.8	2.7	mH
Moment of rotor inertia	J	1156 [10231.5]	1156 [10231.5]	kgcm ² [lb-in.sec ² x 10 ⁻⁴]
Weight (without brake)	m	176 [388.0]	176 [388.0]	kg [lb]
Recommended cable section (4x)	S	35	35	mm ²
Liquid flow rate	Q	8	8	l/min
Recommended terminal type	-	Connection box	Connection box	-

Notes:

- motor performance levels measured with Moog drives of the appropriate size
- performance in continuous service with $\Delta\theta$ winding = 105°C
- number of motor poles: 8
- DC Link voltage 565V
- handbrake available upon request
- personalised windings available upon request

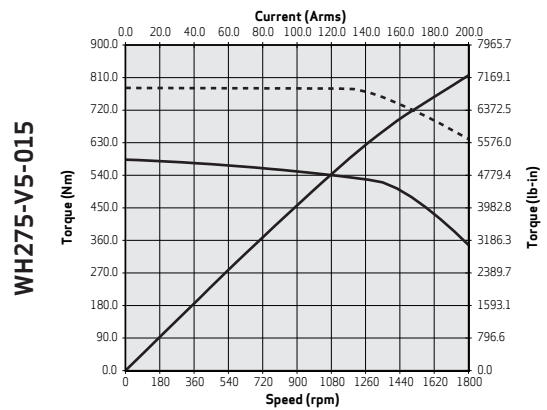
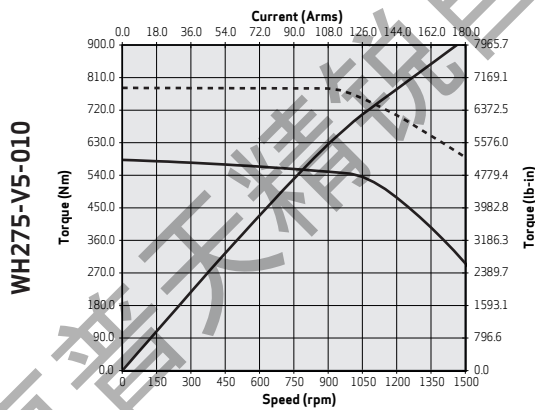

Size WH275 - Liquid cooling				
Characteristics and nominal values with sinusoidal drives				
Size		WH275-P5-008	WH275-P7-008	Units
Nominal torque, continuous service, locked rotor	M_O	602.0[5328.2]	831.0[7355.0]	Nm [lb.in]
Nominal torque, continuous service, nominal speed	M_N	536.7[4750.3]	730.9[6469.0]	Nm [lb.in]
Maximum torque	M_{max}	1232[10904.1]	1712[15152.5]	Nm [lb.in]
Nominal speed	n_N	800	800	rpm
Maximum speed	n_{max}	1039	1019	rpm
Rated current, locked rotor	I_O	84.2	113.8	Arms
Peak current	I_p	220	300	Arms
Power yield in continuous service at nominal speed	P_N	45.0 [60.29]	61.2 [82.10]	kW [hp]
Torque constant	k_T	7.15 [63.3]	7.30 [64.6]	Nm/Arms [lb-in/Arms]
Voltage constant	k_e	442.8	451.4	Vrms/krpm
Thermal time constant	τ_{Th}	1950	2400	sec
Resistance between the phases at 25°C	R_{tt}	0.19	0.13	Ohm
Inductance between the phases	L_{tt}	4.6	3.4	mH
Moment of rotor inertia	J	1156 [10231.5]	1600 [14161.2]	kgcm ² [lb.in.sec ² x 10 ⁻⁴]
Weight (without brake)	m	176 [388.0]	229 [504.9]	kg [lb]
Recommended cable section (4x)	S	25	35	mm ²
Liquid flow rate	Q	8	10	l/min
Recommended terminal type	-	Connection box	Connection box	-

Notes:

- motor performance levels measured with Moog drives of the appropriate size
- performance in continuous service with $\Delta\theta$ winding = 105°C
- number of motor poles: 16
- DC Link voltage 565V
- handbrake available upon request
- personalised windings available upon request

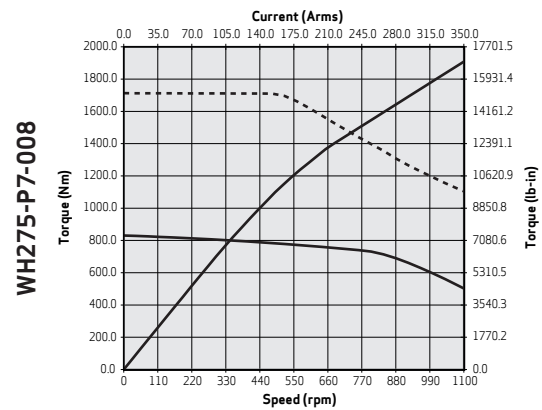
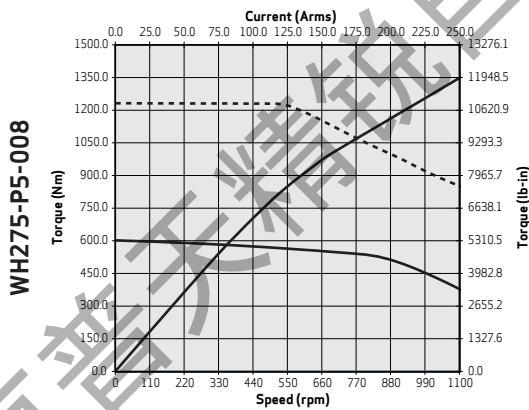

Drawings

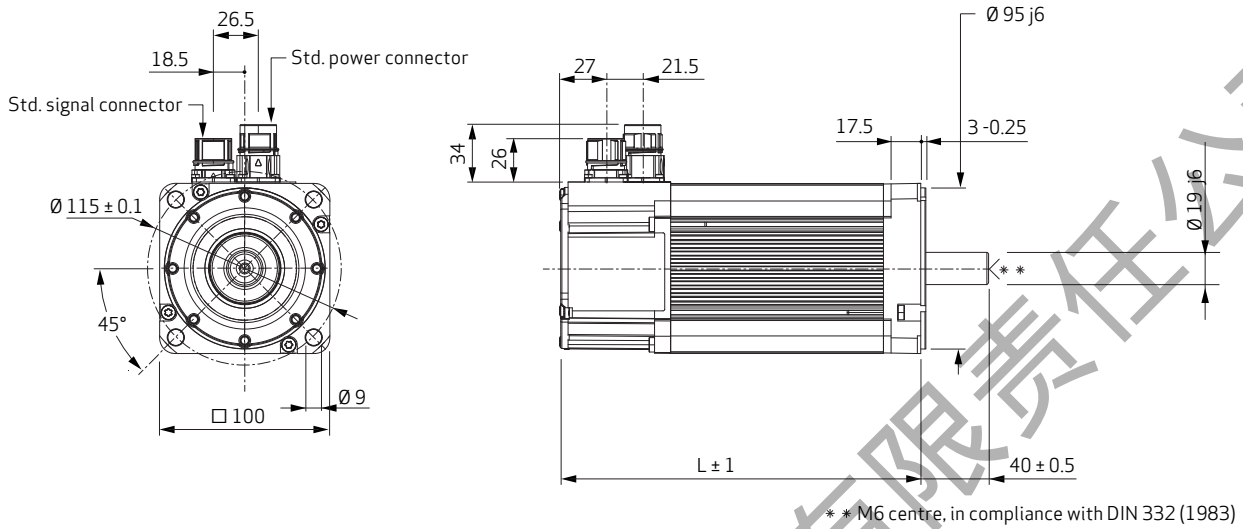

H100					
No. of modules	L	L (Brake)	No. of modules	L	L (Brake)
2	169mm/6.65 inches	213mm/8.39 inches	6	257mm/10.12 inches	301mm/11.85 inches
4	213mm/8.39 inches	257mm/10.12 inches	8	301mm/11.85 inches	345mm/13.58 inches

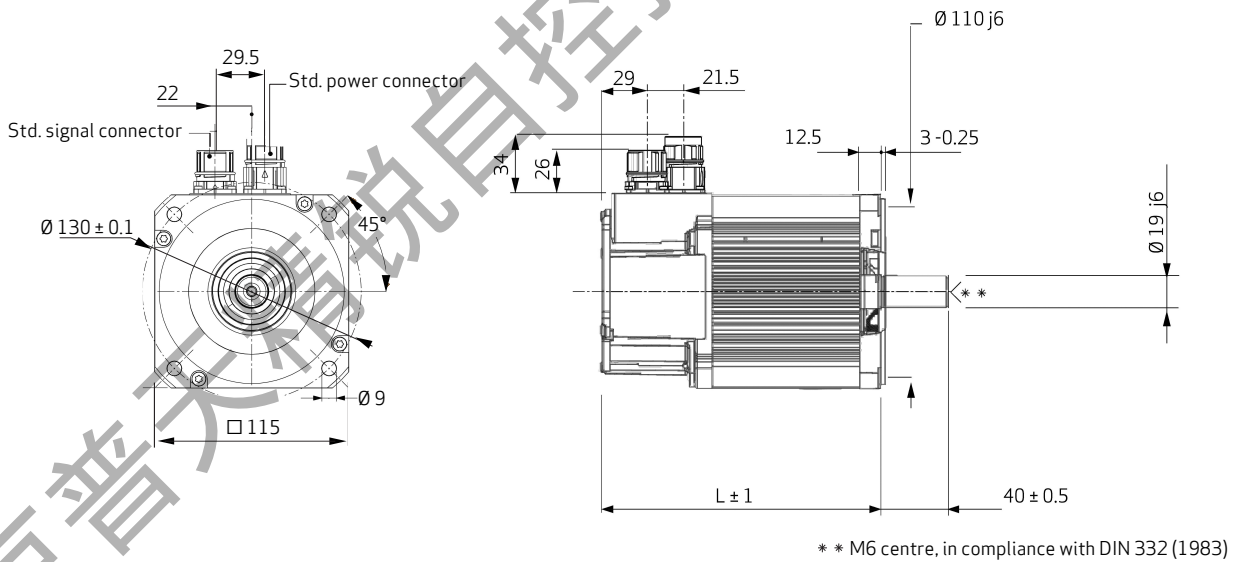

H115		
No. of modules	L	L (Brake)
2	167mm/6.57 inches	210mm/8.26 inches
4	210mm/8.26 inches	253mm/9.96 inches
6	253mm/9.96 inches	306mm/12.05 inches

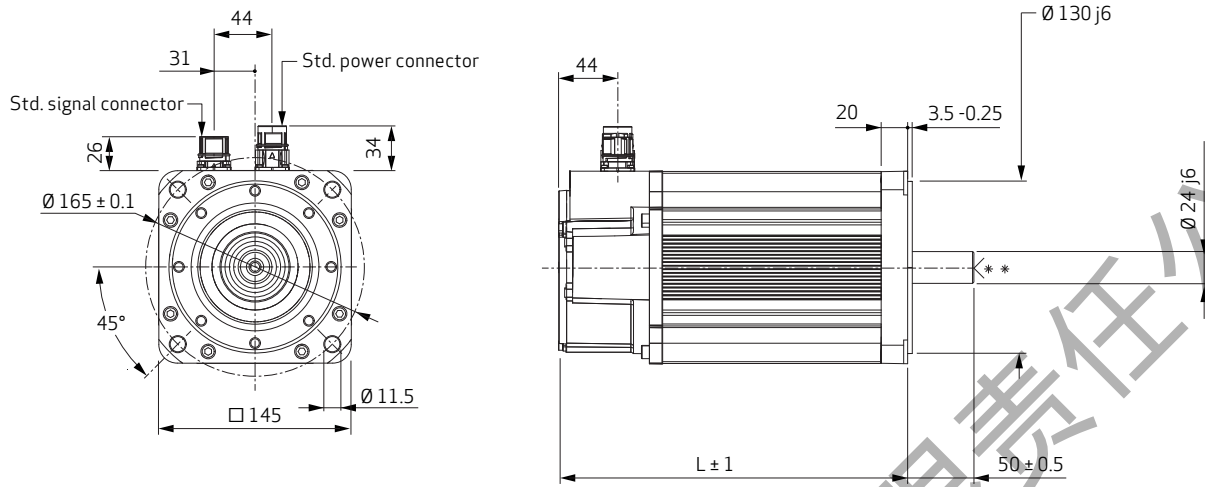

** M8 centre, in compliance with DIN 332 (1983)

H145					
No. of modules	L	L (Brake)	No. of modules	L	L (Brake)
2	209.5mm/8.25 inches	263.5mm/10.37 inches	6	317.5mm/12.5 inches	371.5mm/14.63 inches
4	263.5mm/10.37 inches	317.5mm/12.5 inches	8	371.5mm/14.63 inches	425.5mm/16.75 inches

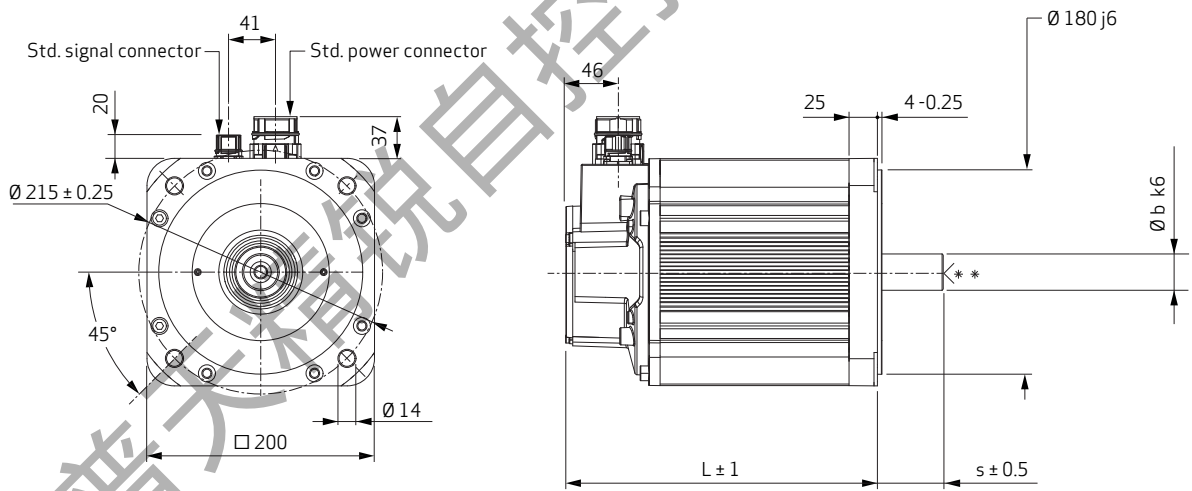

** M12 centre in compliance with DIN 332 (1983) for 2/3-module versions
M16 centre in compliance with DIN 332 (1983) for 4/6/8-module versions

H200					
No. of modules	L	L (Brake)	No. of modules	L	L (Brake)
2	275mm/10.83 inches	275mm/10.83 inches	6	459mm/18.07 inches	518mm/20.39 inches
3	321mm/12.64 inches	321mm/12.64 inches	8	551mm/21.69 inches	610mm/24.00 inches
4	367mm/14.45 inches	426mm/16.77 inches			
No. of modules	b	s			
2 - 3	32mm/1.26 inches	58mm/2.28 inches			
4 - 6 - 8	42mm/1.65 inches	82mm/3.23 inches			

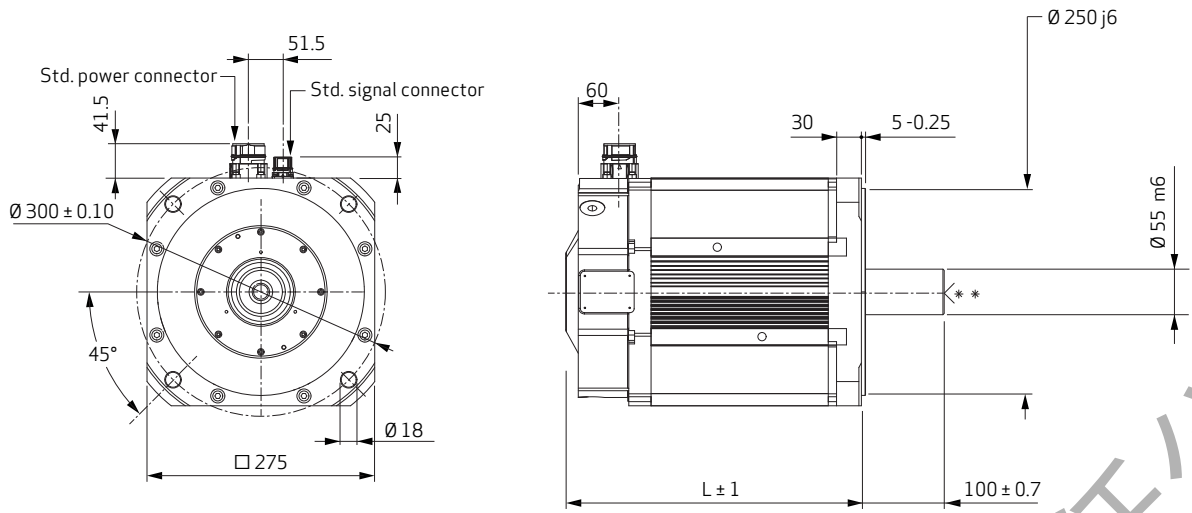

H275	
No. of modules	L
3	433mm/17.05 inches
4	517mm/20.35 inches
5	603mm/23.74 inches

** M20 centre, in compliance with DIN 332 (1983)

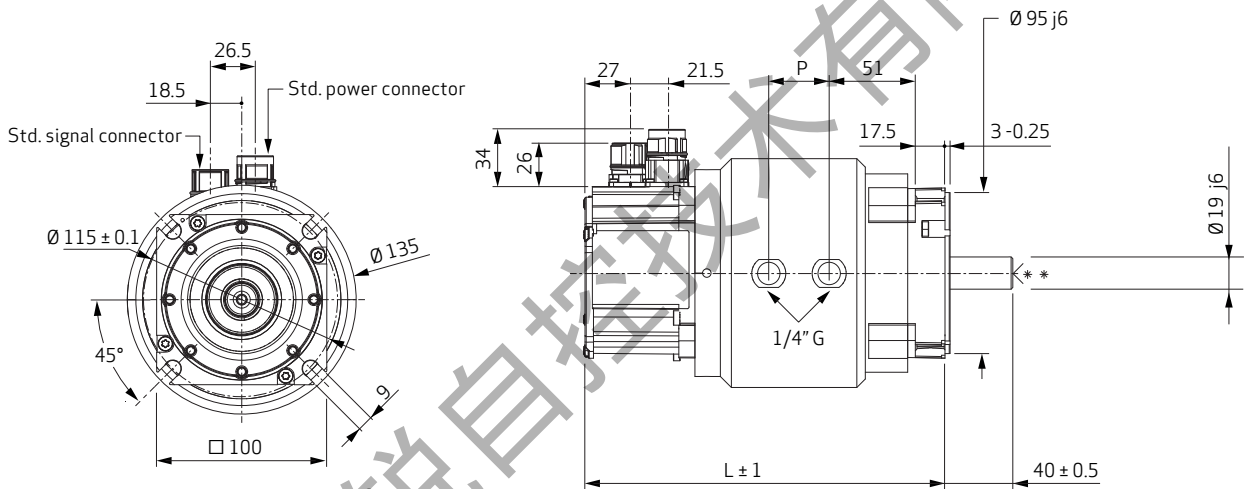

** M6 centre, in compliance with DIN 332 (1983)

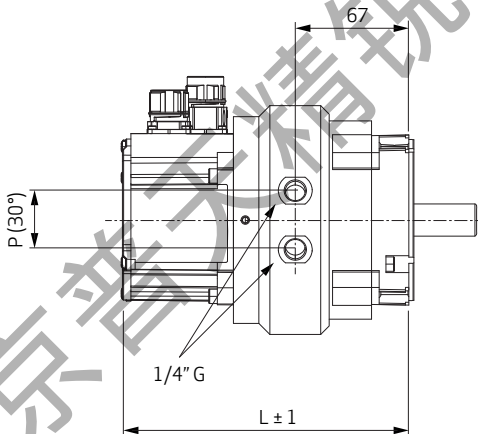

Configuration of 2-module brakeless motor

WH100					
No. of modules	L	P	No. of modules	L	P
2	169mm/6.65 inches	35.5mm/1.40 inches	6	257mm/10.12 inches	79.5mm/3.13 inches
4	213mm/8.39 inches	35.5mm/1.40 inches	8	301mm/11.85 inches	123.5mm/4.86 inches

WH100 (brake)					
No. of modules	L	P	No. of modules	L	P
2	213mm/8.39 inches	35.5mm/1.40 inches	6	301mm/11.85 inches	123.5mm/4.86 inches
4	257mm/10.12 inches	79.5mm/3.13 inches	8	345mm/13.58 inches	167.5mm/6.59 inches

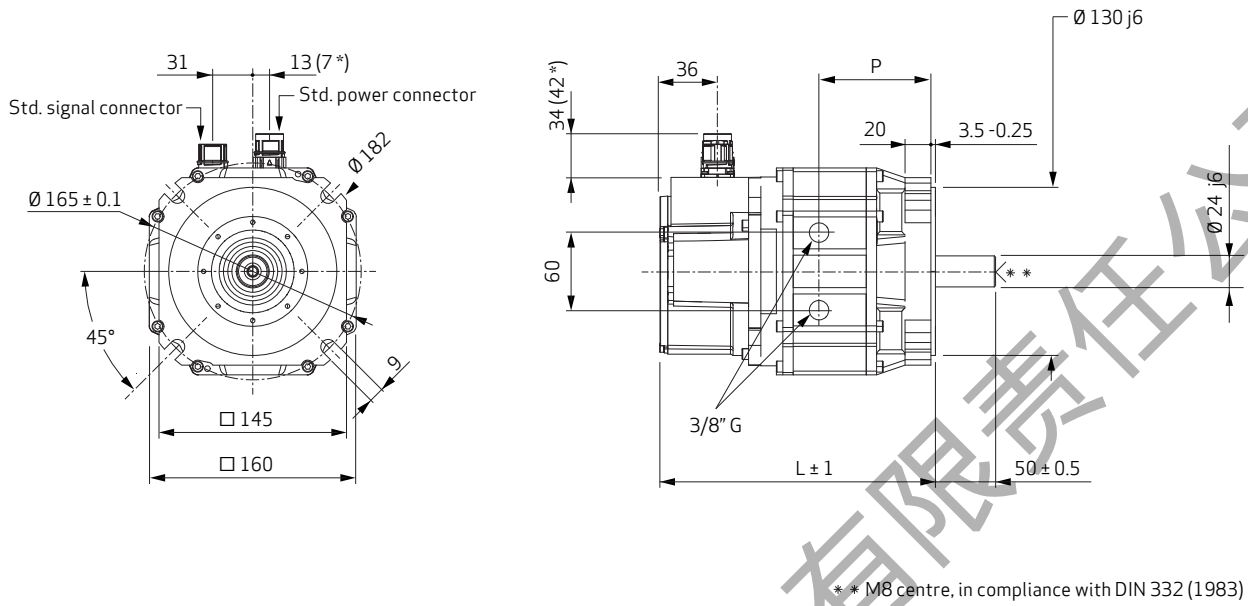

WH145					
No. of modules	L	P	No. of modules	L	P
2	210mm/8.27 inches	86.5mm/3.41 inches	6	318mm/12.52 inches	194.5mm/7.66 inches
4	264mm/10.39 inches	140.5mm/5.53 inches	8	372mm/14.65 inches	248.5mm/9.78 inches

WH145 (brake)					
No. of modules	L	P	No. of modules	L	P
2	264mm/10.39 inches	140.5mm/5.53 inches	6	372mm/14.65 inches	248.5mm/9.78 inches
4	318mm/12.52 inches	194.5mm/7.66 inches	8	426mm/16.77 inches	302.5mm/11.91 inches

(*) Motors with 6 and 8 modules, power connector 1.5

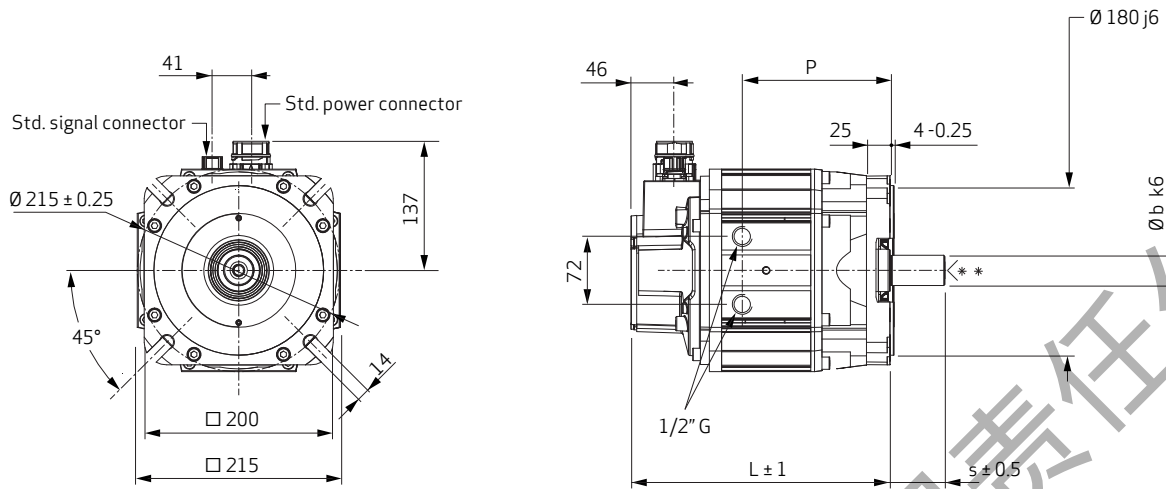

** M12 centre in compliance with DIN 332 (1983) for 2/3-module versions
 M16 centre in compliance with DIN 332 (1983) for 4/5/6/8-module versions

WH200					
No. of modules	L	P	No. of modules	L	P
2	275mm/10.83 inches	157mm/6.18 inches	5	413mm/16.26 inches	295mm/11.61 inches
3	321mm/12.64 inches	203mm/7.99 inches	6	459mm/18.07 inches	341mm/13.43 inches
4	367mm/14.45 inches	249mm/9.80 inches	8	551mm/21.69 inches	433mm/17.05 inches

WH200 (brake)					
No. of modules	L	P	No. of modules	L	P
2	321mm/12.64 inches	203mm/7.99 inches	5	505mm/19.88 inches	387mm/15.24 inches
3	367mm/14.45 inches	249mm/9.80 inches	6	551mm/21.69 inches	433mm/17.05 inches
4	459mm/18.07 inches	341mm/13.43 inches	8	643mm/25.31 inches	525mm/20.67 inches

No. of modules	b	s
2 - 3	32mm/1.26 inches	58mm/2.28 inches
4 - 5 - 6 - 8	42mm/1.65 inches	82mm/3.23 inches

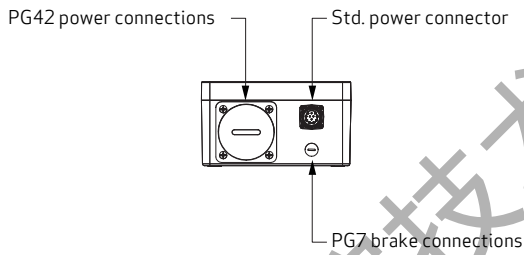
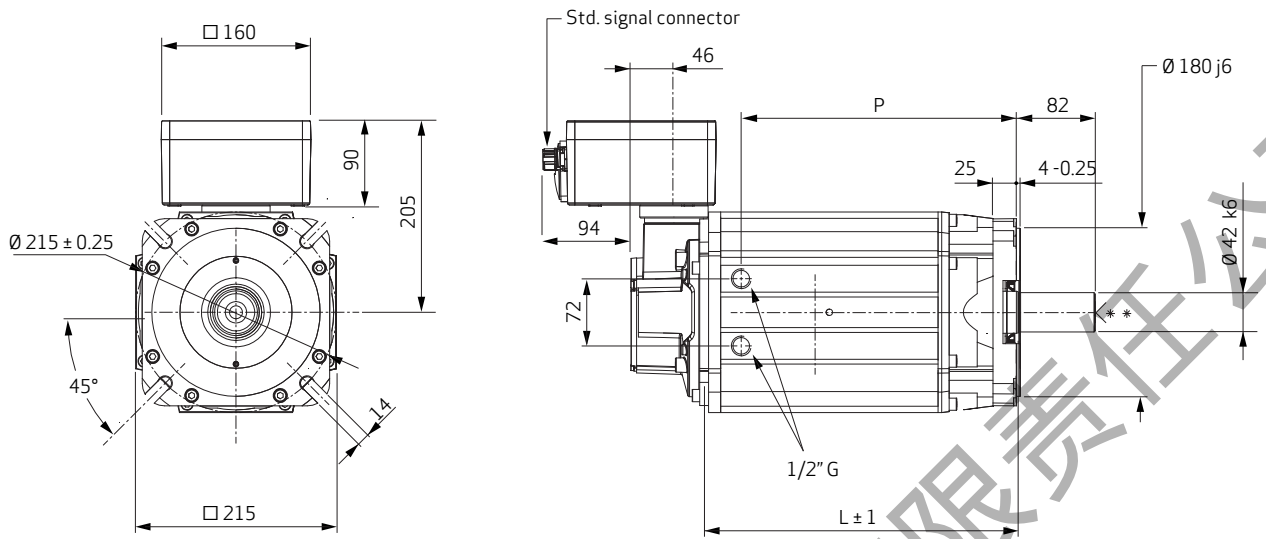

** M16 centre in compliance with DIN 332 (1983)

Dimensions for the following configurations:

- WH200-V5-033
- WH200-V8-020
- WH200-P5-026
- WH200-P6-022
- WH200-P8-018

WH200		
No. of modules	L	P
5	413mm/16.26 inches	295mm/11.61 inches
6	459mm/18.07 inches	341mm/13.43 inches
8	551mm/21.69 inches	433mm/17.05 inches

WH200 (brake)		
No. of modules	L	P
5	505mm/19.88 inches	387mm/15.24 inches
6	551mm/21.69 inches	433mm/17.05 inches
8	643mm/25.31 inches	525mm/20.67 inches

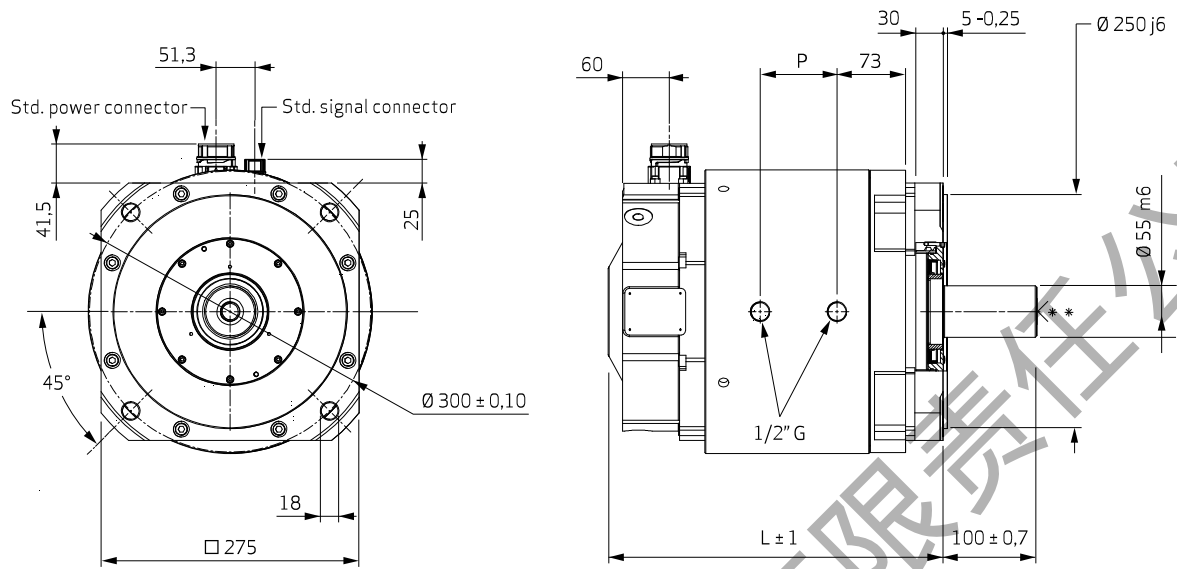

Dimensions for configuration WH275-P3-008

** M20 centre in compliance with DIN 332 (1983)

WH275		
No. of modules	L	P
3	433mm/17.05 inches	158mm/6.22 inches

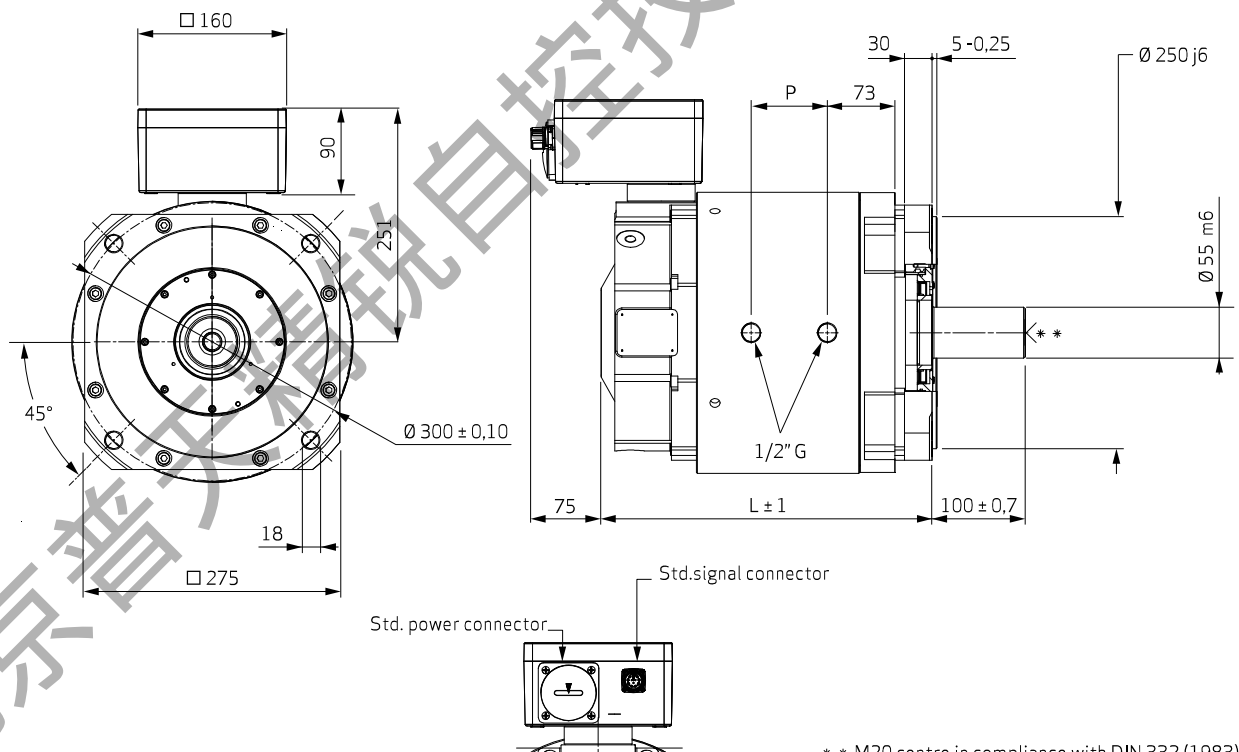

** M20 centre in compliance with DIN 332 (1983)

WH275		
No. of modules	L	P
3	433mm/17.05 inches	158mm/6.22 inches
4	517mm/20.35 inches	242mm/11.61 inches
5	603mm/23.74 inches	328mm/13.43 inches
7	800mm/21.69 inches	525mm/17.05 inches

Mechanical options and eccentricity data

Shaft with key, in compliance with IEC 72-1 (1991)

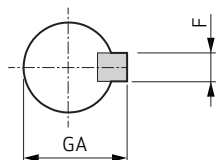
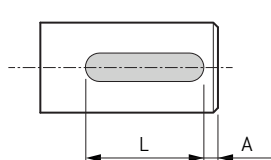

Type	H100	H115	H145	H200 2m/3m	H200 4/6/8m	H275	WH100	WH145	WH200 2m/3m	WH200 4/6/8m	WH275
L	25	25	32	40	70	75	25	32	40	70	75
A	3	3	3	4	5	5	3	3	4	5	5
GA	21.5	21.5	27	35	45	59	21.5	27	35	45	59
F	6	6	8	10	12	16	6	8	10	12	16

Eccentricity in compliance with IEC 72-1 (1991)

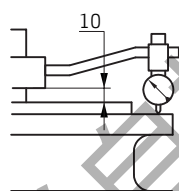
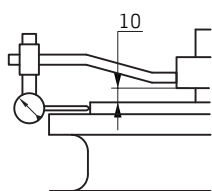

Type	H100	H115	H145	H200	H275	WH100	WH145	WH200	WH275
Tolerance Tolerance values	0.040	0.050	0.050	0.050	0.063	0.040	0.050	0.050	0.063

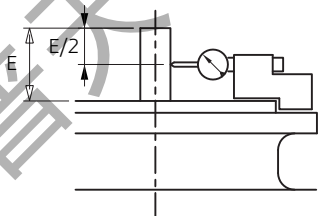

Type	H100	H115	H145	H200	H275	WH100	WH145	WH200	WH275
Tolerance Tolerance values	0.021	0.021	0.021	0.025	0.030	0.021	0.021	0.025	0.030

Radial load diagrams

Loads on bearings

Radial load

The curves show the permitted radial load applied to the middle of the shaft outlet.

The load curves refer to a bearing working life of 20000 h (L10h), with a reliability level of 90%.

The load values are only valid for horizontal motor assembly, without any additional axial force.

Axial load

If components such as pulleys, shrink discs etc. are fitted on the shaft, they must not affect the axial loads.

In any case, the maximum axial load must not be more than 20-30% of the radial load.

H100 / WH100 V2, V4

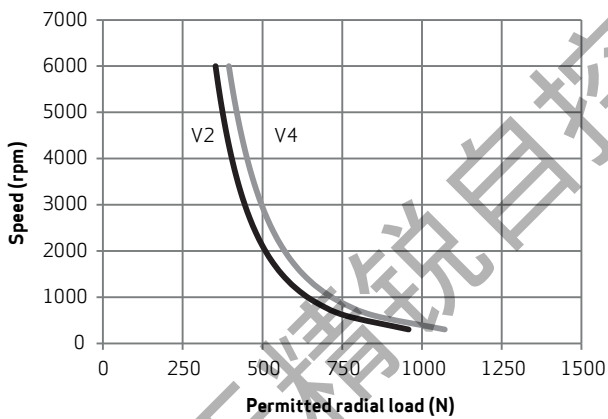

H100 / WH100 V6, V8

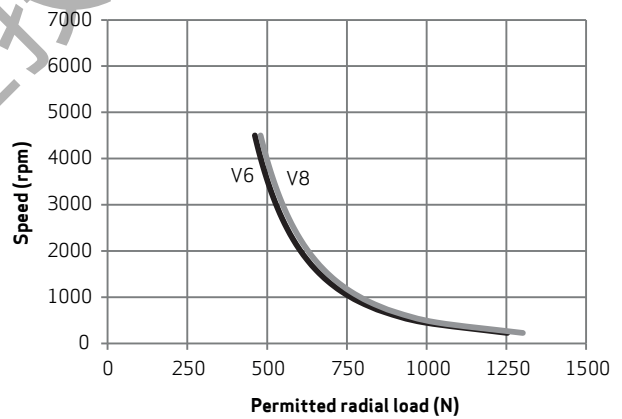

H115 V2, V4, V6

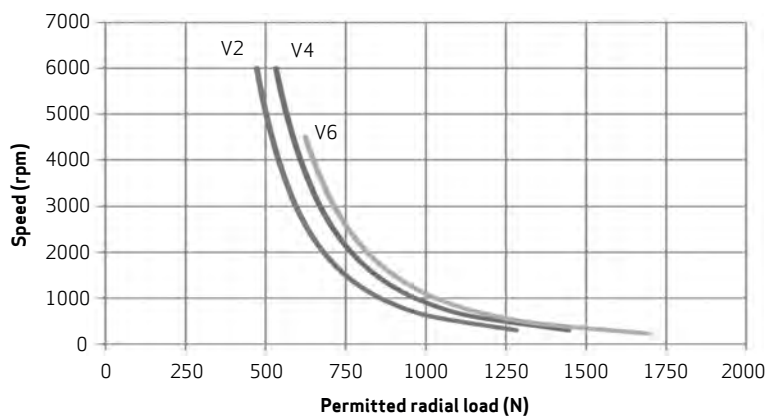

H145/WH145 V2, V4

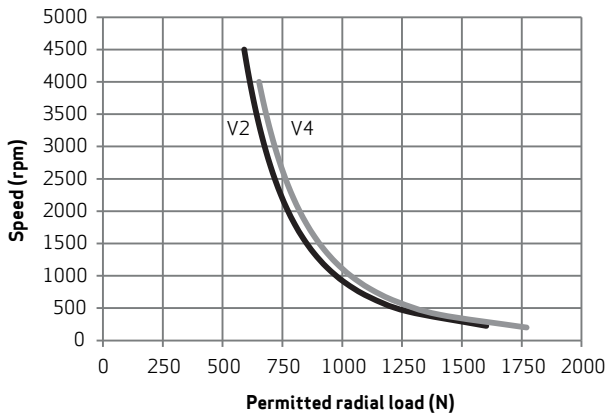

H145/WH145 V6, V8

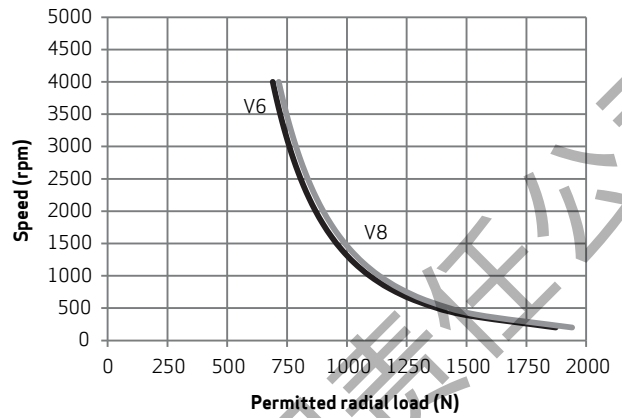

H200V and P/WH200V and P V2, V3, V4

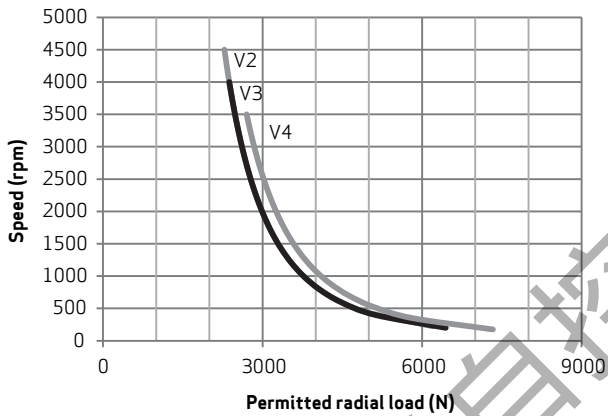

H200V and P/WH200V and P V5, V6, V8

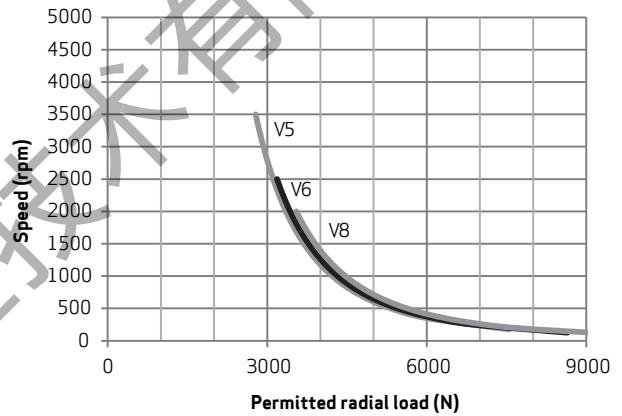

H275V / WH275V and P V3, V4

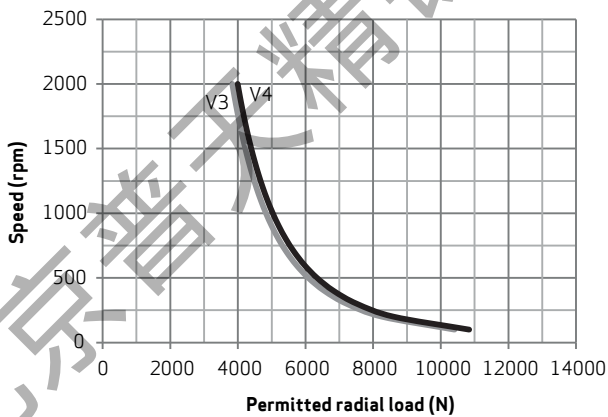

H275V / WH275V and P V5, V7

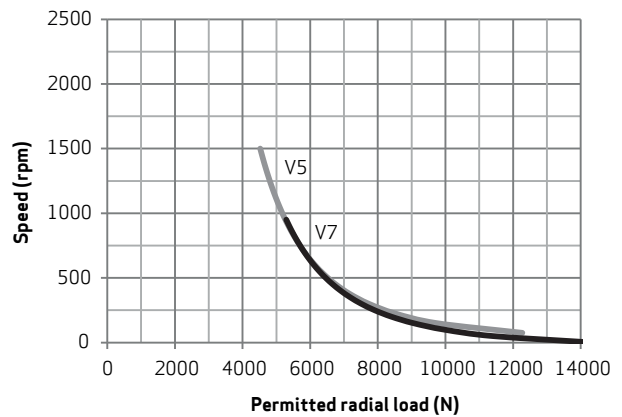

Signal and power connection

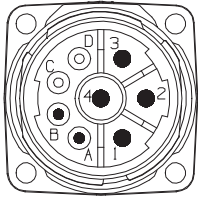

Power connector Size 1	
Contact	Function
1	U
2	PE
3	W
4	V
A	Brake +
B	Brake -
C	n.c.
D	n.c.

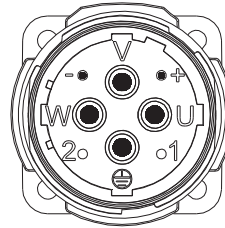

Power connector Size 1.5	
Contact	Function
U	U
GND	PE
V	V
W	W
+	Brake +
-	Brake -
1	n.c.
2	n.c.

Connection box

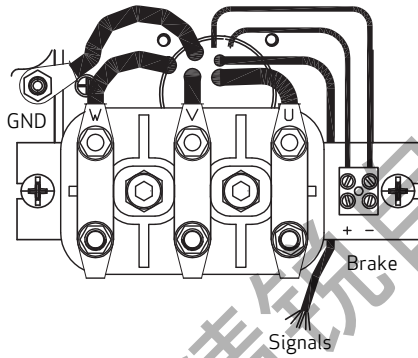

北京普天精銳自控技术有限公司

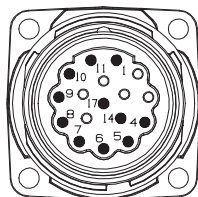

Endat22 encoder signal connector	
Contact	Function
1	UP sensor
2	n.c.
3	n.c.
4	OV sensor
5	Therm. prot.
6	Therm. prot.
7	Up
8	Clock
9	Clock
10	OV
11	Screen
12	n.c.
13	n.c.
14	Date
15	n.c.
16	n.c.
17	Date

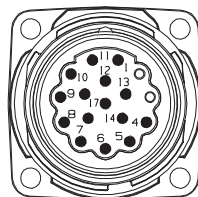

Endat01 encoder signal connector	
Contact	Function
1	UP sensor
2	n.c.
3	n.c.
4	OV sensor
5	Therm. prot.
6	Therm. prot.
7	Up
8	Clock
9	Clock
10	OV
11	Screen
12	B+
13	B-
14	Date
15	A+
16	A-
17	Date

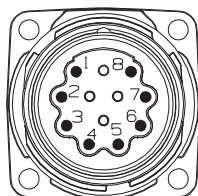

Resolver signal connector	
Contact	Function
1	S1
2	S3
3	S2
4	S4
5	Therm. prot.
6	Therm. prot.
7	R1
8	R2
9	n.c.
10	n.c.
11	n.c.
12	n.c.

北京普天精密控制技术股份有限公司

Cables, connectors and wiring

Signal cable: low-capacity multi-pole wire with AWG 22 conductors (0.38mm²) paired, intertwined and shielded, with an additional external liner shield.

The cable must be no longer than 40 metres, and it must be separated from the power cable and brake cable by at least 30cm.

Power cable: shielded quadrupole cable with a recommended section as shown in the technical data table.

Brake cable: shielded 0.6-pole mm min. (20 AWG).

EMC

For compliance with Directive 89/336/EC (EMC), and for correct system operation, the signal and power cables must be shielded (minimum cover 85%). The shield must be connected to the frame at both ends, using a radio frequency connection (i.e. 360°).

In the case of a connector, the connection must be made with a cable relief; in the case of a terminal block, use a metal cable gland.

To order cables and connectors

To order cables:

Moog supplies cables up to 40 metres with a 5-metre modularity. For cables longer than 40 metres, it may be necessary to evaluate - together with our Application department - the use of a filter between the drive and the motor.

Fastact H motors can be ordered with power and signal cables complete with connectors. Mobile connectors can also be ordered separately.

POWER CABLES

Find the code of the power cable corresponding to the required motor in the tables below. The power cable includes the connector on the motor side. The cable, on the drive side, has no connection, as the connector changes depending on the drive used.

In the code, the value "XX" must be replaced by the cable length.

EXAMPLE OF A COMPLETE CODE:

CVF P10 – 1020-21

Power cable, fixed installation, 10 metres long.

POWER CABLES FOR MOTORS WITH NATURAL COOLING			
MOTOR WITH NATURAL COOLING	CONNECTOR (8 PIN)	FIXED INSTALLATION	MOBILE INSTALLATION
H100	Size 1	CVF Pxx-1020-21	CVM Pxx-1020-21
H115	Size 1	CVF Pxx-1020-21	CVM Pxx-1020-21
H145 V2 - V4	Size 1	CVF Pxx-1020-21	CVM Pxx-1020-21
H145-V6-020	Size 1	CVF Pxx-1020-21	CVM Pxx-1020-21
H145-V6-030	Size 1	CVF Pxx-1020-21	CVM Pxx-1020-21
H145-V6-040	Size 1	CVF Pxx-1030-31	CVM Pxx-1030-31
H145-V8-020	Size 1	CVF Pxx-1020-21	CVM Pxx-1020-21
H145-V8-030	Size 1	CVF Pxx-1030-31	CVM Pxx-1030-31
H145-V8-040	Size 1	CVF Pxx-1030-41	CVM Pxx-1030-41
H200-V2-020	Size 1.5	CVF Pxx-3030-41	CVM Pxx-3030-41
H200-V2-030	Size 1.5	CVF Pxx-3030-41	CVM Pxx-3030-41
H200-V2-045	Size 1.5	CVF Pxx-3030-51	CVM Pxx-3030-51
H200-V3-020	Size 1.5	CVF Pxx-3030-41	CVM Pxx-3030-41
H200-V3-030	Size 1.5	CVF Pxx-3030-51	CVM Pxx-3030-51
H200-V3-039	Size 1.5	CVF Pxx-3030-51	CVM Pxx-3030-51
H200-V4-014	Size 1.5	CVF Pxx-3030-41	CVM Pxx-3030-41
H200-V4-020	Size 1.5	CVF Pxx-3030-41	CVM Pxx-3030-41
H200-V4-030	Size 1.5	CVF Pxx-3030-51	CVM Pxx-3030-51
H200-V6-012	Size 1.5	CVF Pxx-3030-41	CVM Pxx-3030-41
H200-V6-020	Size 1.5	CVF Pxx-3030-51	CVM Pxx-3030-51
H200-V6-025	Size 1.5	CVF Pxx-3030-61	CVM Pxx-3030-61
H200-V8-012	Size 1.5	CVF Pxx-3030-41	CVM Pxx-3030-41
H200-V8-016	Size 1.5	CVF Pxx-3030-51	CVM Pxx-3030-51
H200-V8-020	Size 1.5	CVF Pxx-3030-61	CVM Pxx-3030-61
H200-P2-014	Size 1.5	CVF Pxx-3030-41	CVM Pxx-3030-41
H200-P2-022	Size 1.5	CVF Pxx-3030-41	CVM Pxx-3030-41
H200-P2-030	Size 1.5	CVF Pxx-3030-41	CVM Pxx-3030-41
H200-P3-014	Size 1.5	CVF Pxx-3030-41	CVM Pxx-3030-41
H200-P3-018	Size 1.5	CVF Pxx-3030-41	CVM Pxx-3030-41
H200-P3-022	Size 1.5	CVF Pxx-3030-41	CVM Pxx-3030-41
H200-P4-014	Size 1.5	CVF Pxx-3030-41	CVM Pxx-3030-41
H200-P4-018	Size 1.5	CVF Pxx-3030-41	CVM Pxx-3030-41
H200-P4-020	Size 1.5	CVF Pxx-3030-51	CVM Pxx-3030-51
H200-P6-011	Size 1.5	CVF Pxx-3030-41	CVM Pxx-3030-41
H200-P6-015	Size 1.5	CVF Pxx-3030-51	CVM Pxx-3030-51
H200-P6-018	Size 1.5	CVF Pxx-3030-51	CVM Pxx-3030-51
H200-P8-008	Size 1.5	CVF Pxx-3030-41	CVM Pxx-3030-41
H200-P8-010	Size 1.5	CVF Pxx-3030-41	CVM Pxx-3030-41
H200-P8-014	Size 1.5	CVF Pxx-3030-51	CVM Pxx-3030-51
H275-V3-012	Size 1.5	CVF Pxx-3030-61	CVM Pxx-3030-61
H275-V4-010	Size 1.5	CVF Pxx-3030-61	CVM Pxx-3030-61
H275-V4-015	Size 1.5	CVF Pxx-3030-71	CVM Pxx-3030-71
H275-V5-010	Size 1.5	CVF Pxx-3030-71	CVM Pxx-3030-71

POWER CABLES FOR LIQUID COOLED MOTORS			
MOTOR	CONNECTOR (8 PIN)	FIXED INSTALLATION	MOBILE INSTALLATION
WH100-V2-030	Size 1	CVF Pxx-1020-21	CVM Pxx-1020-21
WH100-V2-045	Size 1	CVF Pxx-1020-21	CVM Pxx-1020-21
WH100-V2-060	Size 1	CVF Pxx-1020-21	CVM Pxx-1020-21
WH100-V4-030	Size 1	CVF Pxx-1020-21	CVM Pxx-1020-21
WH100-V4-045	Size 1	CVF Pxx-1020-21	CVM Pxx-1020-21
WH100-V4-060	Size 1	CVF Pxx-1020-21	CVM Pxx-1020-21
WH100-V6-020	Size 1	CVF Pxx-1020-21	CVM Pxx-1020-21
WH100-V6-030	Size 1	CVF Pxx-1020-21	CVM Pxx-1020-21
WH100-V6-045	Size 1	CVF Pxx-1030-31	CVM Pxx-1030-31
WH100-V8-020	Size 1	CVF Pxx-1020-21	CVM Pxx-1020-21
WH100-V8-030	Size 1	CVF Pxx-1020-21	CVM Pxx-1020-21
WH100-V8-045	Size 1	CVF Pxx-1030-31	CVM Pxx-1030-31
WH145-V2-020	Size 1	CVF Pxx-1020-21	CVM Pxx-1020-21
WH145-V2-030	Size 1	CVF Pxx-1020-21	CVM Pxx-1020-21
WH145-V2-045	Size 1	CVF Pxx-1030-31	CVM Pxx-1030-31
WH145-V4-020	Size 1	CVF Pxx-1030-31	CVM Pxx-1030-31
WH145-V4-030	Size 1	CVF Pxx-1030-41	CVM Pxx-1030-41
WH145-V4-040	Size 1	CVF Pxx-1030-41	CVM Pxx-1030-41
WH145-V6-020	Size 1.5	CVF Pxx-3030-41	CVM Pxx-3030-41
WH145-V6-030	Size 1.5	CVF Pxx-3030-51	CVM Pxx-3030-51
WH145-V6-040	Size 1.5	CVF Pxx-3030-61	CVM Pxx-3030-61
WH145-V8-020	Size 1.5	CVF Pxx-3030-51	CVM Pxx-3030-51
WH145-V8-030	Size 1.5	CVF Pxx-3030-61	CVM Pxx-3030-61
WH145-V8-040	Size 1.5	CVF Pxx-3030-71	CVM Pxx-3030-71
WH200-V2-020	Size 1.5	CVF Pxx-3030-41	CVM Pxx-3030-41
WH200-V2-030	Size 1.5	CVF Pxx-3030-51	CVM Pxx-3030-51
WH200-V2-045	Size 1.5	CVF Pxx-3030-61	CVM Pxx-3030-61
WH200-V3-020	Size 1.5	CVF Pxx-3030-51	CVM Pxx-3030-51
WH200-V3-030	Size 1.5	CVF Pxx-3030-61	CVM Pxx-3030-61
WH200-V3-039	Size 1.5	CVF Pxx-3030-71	CVM Pxx-3030-71
WH200-V4-014	Size 1.5	CVF Pxx-3030-41	CVM Pxx-3030-41
WH200-V4-020	Size 1.5	CVF Pxx-3030-61	CVM Pxx-3030-61
WH200-V4-030	Size 1.5	CVF Pxx-3030-71	CVM Pxx-3030-71
WH200-V5-020	Size 1.5	CVF Pxx-3030-61	CVM Pxx-3030-61
WH200-V5-025	Size 1.5	CVF Pxx-3030-71	CVM Pxx-3030-71
WH200-V5-033	CONNECTION BOX		
WH200-V6-012	Size 1.5	CVF Pxx-3030-61	CVM Pxx-3030-61
WH200-V6-020	Size 1.5	CVF Pxx-3030-71	CVM Pxx-3030-71
WH200-V6-025	Size 1.5	CVF Pxx-3030-71	CVM Pxx-3030-71
WH200-V8-012	Size 1.5	CVF Pxx-3030-61	CVM Pxx-3030-61
WH200-V8-016	Size 1.5	CVF Pxx-3030-71	CVM Pxx-3030-71
WH200-V8-020	CONNECTION BOX		

POWER CABLES FOR LIQUID COOLED MOTORS			
MOTOR	CONNECTOR (8 PIN)	FIXED INSTALLATION	MOBILE INSTALLATION
WH200-P2-014	Size 1.5	CVF Pxx-3030-41	CVM Pxx-3030-41
WH200-P2-022	Size 1.5	CVF Pxx-3030-41	CVM Pxx-3030-41
WH200-P2-035	Size 1.5	CVF Pxx-3030-61	CVM Pxx-3030-61
WH200-P3-018	Size 1.5	CVF Pxx-3030-51	CVM Pxx-3030-51
WH200-P3-022	Size 1.5	CVF Pxx-3030-61	CVM Pxx-3030-61
WH200-P3-035	Size 1.5	CVF Pxx-3030-71	CVM Pxx-3030-71
WH200-P4-014	Size 1.5	CVF Pxx-3030-51	CVM Pxx-3030-51
WH200-P4-018	Size 1.5	CVF Pxx-3030-61	CVM Pxx-3030-61
WH200-P4-027	Size 1.5	CVF Pxx-3030-71	CVM Pxx-3030-71
WH200-P5-014	Size 1.5	CVF Pxx-3030-61	CVM Pxx-3030-61
WH200-P5-018	Size 1.5	CVF Pxx-3030-71	CVM Pxx-3030-71
WH200-P5-026	CONNECTION BOX		
WH200-P6-011	Size 1.5	CVF Pxx-3030-61	CVM Pxx-3030-61
WH200-P6-015	Size 1.5	CVF Pxx-3030-71	CVM Pxx-3030-71
WH200-P6-022	CONNECTION BOX		
WH200-P8-010	Size 1.5	CVF Pxx-3030-61	CVM Pxx-3030-61
WH200-P8-014	Size 1.5	CVF Pxx-3030-71	CVM Pxx-3030-71
WH200-P8-018	CONNECTION BOX		
WH275-V3-012	CONNECTION BOX		
WH275-V3-020	CONNECTION BOX		
WH275-V4-010	CONNECTION BOX		
WH275-V4-015	CONNECTION BOX		
WH275-V5-010	CONNECTION BOX		
WH275-V5-015	CONNECTION BOX		
WH275-P3-008	Size 1.5	CVF Pxx-3030-71	CVM Pxx-3030-71
WH275-P3-011	CONNECTION BOX		
WH275-P4-011	CONNECTION BOX		
WH275-P5-008	CONNECTION BOX		
WH275-P7-008	CONNECTION BOX		

SIGNAL CABLES

The signal cable includes connectors on the motor side and drive side. The cable for connecting to motors with resolver transducer is compatible with Moog DS2000, DS2020, DM2020 drives; the one for the encoder transducer communicates with Moog DS2020 and DM2020 drives.

TYPE OF TRANSDUCER	FIXED INSTALLATION CABLE CODE	MOBILE INSTALLATION CABLE CODE
RESOLVER	CVF Sxx-4040-03	CVM Sxx-4040-03
ENCODER	CVF Sxx-5030-03	CVM Sxx-5030-03

In the code, the value "XX" must be replaced by the cable length.

TO ORDER MOBILE CONNECTORS:

Power cable connector:

CONNECTOR SIZE	CABLE DIMENSIONS	CODE FOR MOTOR SIDE CONNECTOR
1	<ul style="list-style-type: none"> Cable outer diameter from 7.5 to 12 mm Copper section 0.35 – 2.5 mm² 	CB73791-002
1.5	<ul style="list-style-type: none"> Cable outer diameter from 9 to 16 mm Copper section 1.50 - 10 mm² 	CB74642-003
1.5	<ul style="list-style-type: none"> Cable outer diameter from 16.5 to 25 mm Copper section 1.50 - 10 mm² 	CB74642-004
1.5	<ul style="list-style-type: none"> Cable outer diameter from 16.5 to 25 mm Copper section 6 - 16 mm² 	CB74642-005

See the power cable tables and technical data to find the connector size corresponding to the motor required.

Signal cable connector:

CODE FOR MOTOR SIDE CONNECTOR
CB73793-005 (12 Contacts)
CB75118-005 (17 Contacts)

北京普天精锐自控技术有限公司

Moog Italiana Srl
Via Avosso 94
16015 Casella
(Genova)

Italy

MOOG
COMPONENTS GROUP

info.casella@moog.com

www.moog.com/components